



AC15 Series

Variable Speed Drive

Hardware Installation Manual

North American Version



1 Safety Requirements

IMPORTANT: Please read this information BEFORE installing the equipment.

The contents of this manual have been verified against the associated hardware and software. Although every effort has been taken to ensure the accuracy of this document, it may be necessary without notice, to make amendments or correct omissions.

Parker Hannifin Manufacturing cannot accept responsibility for damage, injury, or expenses resulting there from.

1.1 Intended Users

This manual is to be made available to all persons who are required to install, configure or service equipment described herein, or any other associated operation.

The information given is intended to highlight safety issues, and to enable the user to obtain maximum benefit from the equipment.

1.2 Application Area





The equipment described is intended for industrial motor speed control utilizing AC induction motors or PMAC motors.

1.3 Personnel

Installation, operation and maintenance of the equipment should be carried out by competent personnel. A competent person is someone who is technically qualified and familiar with all safety information and established safety practices; with the installation process, operation and maintenance of this equipment; and with all the hazards involved.



1.4 Product Warnings, Cautions and Information notices

Special attention must be paid to the information presented in warning, caution and information notices when they appear in this manual. Definitions of caution, warning and information notices are shown below:

	DANGER Risk of electric shock
	WARNING Hot surfaces
	WARNING Warns of danger to personnel. Refer to documentation. CAUTION Warns of danger to equipment. Refer to documentation.
	EARTH / GROUND Protective Earth Conductor Terminal
	INFORMATION Read further information before proceeding.

1.5 Hazards

1.5.1 Electric Shocks

	DANGER!	
	Ignoring the following may result in injury:	
	<ul style="list-style-type: none">• This equipment can endanger life by exposure to rotating machinery and high voltages.• The equipment must be permanently earthed due to the high earth leakage current, and the drive motor must be connected to an appropriate safety earth.• Ensure all incoming supplies are isolated before working on the equipment. Be aware that there may be more than one supply connection to the drive.• There may still be dangerous voltages present at power terminals (motor output, supply input phases, DC bus and the brake, where fitted) when the motor is at standstill or is stopped.• For measurements use only a meter to IEC 61010 (CAT III or higher). Always begin using the highest range. CAT I and CAT II meters must not be used on this product.• Allow at least 10 minutes for the drive's capacitors to discharge to safe voltage levels (<50V). Use the specified meter capable of measuring up to 1000V dc & ac rms to confirm that less than 50V is present between all power terminals and between power terminals and earth.• Unless otherwise stated, this product must NOT be dismantled. In the event of a fault the drive must be returned. Refer to "Routine Maintenance and Repair".	



1.5.2 Safety & EMC Requirements

Where there is a conflict between safety and EMC requirements, personnel safety shall always take precedence.

Safety



	<p>WARNING!</p> <p>Ignoring the following may result in injury or damage to equipment:</p> <ul style="list-style-type: none"> • Never perform high voltage resistance checks on the wiring without first disconnecting the drive from the circuit being tested. • Whilst ensuring ventilation is sufficient, provide guarding and /or additional safety systems to prevent injury or damage to equipment. • When replacing an drive in an application and before returning to use, it is essential that all user defined parameters for the product's operation are correctly installed. • When replacing an drive in an application and before returning to use, it is essential that all user defined parameters for the product's operation are correctly installed. • All control and signal terminals are SELV, i.e. protected by double insulation. Ensure all external wiring is rated for the highest system voltage. • Thermal sensors contained within the motor must have at least basic insulation. • All exposed metalwork in the Drive is protected by basic insulation and bonded to a safety earth. • RCDs are not recommended for use with this product but, where their use is mandatory, only Type B RCDs should be used. 	
---	--	---

EMC



	<p>WARNING!</p> <p>Ignoring the following may result in injury or damage to equipment:</p> <ul style="list-style-type: none"> • In a domestic environment this product may cause radio interference in which case supplementary mitigation measures may be required. • This equipment contains electrostatic discharge (ESD) sensitive parts. Observe static control precautions when handling, installing and servicing this product. • This is a product of the restricted sales distribution class according to IEC 61800-3. It is designated as “professional equipment” as defined in EN61000-3-2 for AC15: Frame sizes 1 (all), 2 (3Ø products only) & 3 (480V products only). Permission of the supply authority shall be obtained before connection to the public low voltage supply. For all other Frame sizes not specified above, connection to the public LV supply must be agreed case by case between manufacturer, installer or user and distribution network operator. 	
---	---	---

1.5.3 Application Risk & Risk Assessment

Application Risk

	CAUTION!	
<ul style="list-style-type: none">• The specifications, processes and circuitry described herein are for guidance only and may need to be adapted to the user's specific application.• Parker cannot guarantee the suitability of the equipment described in this Manual for individual applications.		

Risk Assessment

	CAUTION!	
<ul style="list-style-type: none">• Under fault conditions, power loss or unintended operating conditions, the drive may not operate as intended. In particular:<ul style="list-style-type: none">○ Stored energy might not discharge to safe levels as quickly as suggested and can still be present even though the drive appears to be switched off.○ The motor's direction of rotation might not be controlled.○ The motor speed might not be controlled.○ The motor might be energized.• An drive is a component within an drive system that may influence its operation or effects under a fault condition. Consideration must be given to:<ul style="list-style-type: none">○ Stored energy○ Supply disconnects○ Sequencing logic○ Unintended operation		

2 Manufacturing Location

Germany

Parker Hannifin Manufacturing Germany GmbH & Co. KG

Electric Motion & Pneumatic Division (EMPD)

Robert-Bosch-Strasse 22

77656 Offenburg (Germany)

Tel.: + 49 (0781) 509-0

Website: www.parker.com/eme

Certified according to ISO 9001:2015

Parker Hannifin Manufacturing Germany GmbH & Co. KG - Sitz: Bielefeld - Amtsgericht: Bielefeld HRA 15699
persönlich haftende Gesellschafterin: Parker Hannifin GmbH - Sitz: Bielefeld - Amtsgericht Bielefeld HRB 35489
Geschäftsführung der Parker Hannifin GmbH: Ulrich Jochem, Achim Kohler, Andreas Paulsen, Kirsten Stenvers
Vorsitzender des Aufsichtsrates: Dr.-Ing. Gerd Scheffel

3 Table of Contents

1	Safety Requirements	2
1.1	Intended Users.....	2
1.2	Application Area.....	2
1.3	Personnel.....	2
1.4	Product Warnings, Cautions and Information notices.....	2
1.5	Hazards.....	3
1.5.1	Electric Shocks.....	3
1.5.2	Safety & EMC Requirements.....	4
1.5.3	Application Risk & Risk Assessment.....	5
2	Manufacturing Location	6
3	Table of Contents	7
4	Introduction	10
4.1	About this Hardware Installation Manual.....	10
4.1.1	Users.....	10
4.1.2	Manual Organization.....	10
4.1.3	Manual Revision.....	10
4.2	Before You Start.....	10
4.2.1	Equipment Inspection.....	10
4.2.2	Equipment Storage.....	10
4.2.3	Initial Steps.....	11
4.2.4	Unpacking the Product.....	11
5	Product Overview	12
6	Installation	15
6.1	Mechanical.....	15
6.1.1	Product Dimensions & Weights.....	15
6.1.2	Product Fixing Dimensions.....	16
6.1.3	Lifting the Drive.....	17
6.1.4	Mounting the Drive.....	17
6.1.5	Ventilation Clearance Requirements.....	18
6.1.6	Wiring Bracket (Optional).....	19
6.2	Electrical.....	20
6.2.1	Power Stack Wiring.....	20
6.2.2	Control Board Wiring.....	28
6.2.3	Control Board Communications Wiring.....	32
6.3	µSD Memory Card.....	33
6.3.1	Installation.....	34
6.4	Remote Mounted 6901 MMI.....	35
6.4.1	Order Codes.....	35
6.4.2	Installation.....	35
6.4.3	Cable Connection.....	36
7	Associated Equipment	37
7.1	AC Line Fuses.....	38
7.1.1	1ø, 230V Products.....	38
7.1.2	3ø, 230V Products.....	38
7.1.3	3ø, 480V Products.....	38
7.2	External EMC Filters.....	39
7.3	AC Line Chokes.....	39
7.3.1	1ø, 230V Products.....	39
7.3.2	3ø, 230V Products.....	39
7.3.3	3ø, 480V Products.....	39
7.4	Dynamic Braking Kits.....	40
7.4.1	1ø, 230V Products.....	40
7.4.2	3ø, 230V Products.....	40
7.4.3	3ø, 480V Products.....	40
7.5	Motor Reactor.....	40
8	Safe Torque Off (STO): SIL2, PLd	41

8.1	Overview	41
8.1.1	Introduction.....	41
8.1.2	STO Functional Description	42
8.2	Alignment to European Standards	42
8.2.1	EN ISO13849-1:2015 (Safety of machinery – Safety-related parts of control systems)	42
8.2.2	EN61800-5-2:2017 (Adjustable speed electrical power drive systems) & EN61508:2010 (Functional safety of electrical/electronic/programmable electronic safety-related systems).....	43
8.3	Specification	43
8.3.1	Safety.....	43
8.3.2	EMC.....	44
8.4	STO Operation	44
8.4.1	Terminal Identifications.....	44
8.4.2	Input State Truth Table.....	45
8.4.3	Example Applications	45
8.4.4	Technical Specification.....	50
8.5	STO Safety Warnings & Limitations.....	50
8.6	STO Functional Checks	53
8.6.1	Comprehensive Checks.....	53
8.6.2	Test Protocol Specimen.....	56
8.6.3	Regular Checks.....	56
8.7	STO Troubleshooting.....	57
9	Basic Drive Operation.....	58
9.1	'Local' Operation	58
9.1.1	Minimum Connections	58
9.1.2	Onboard Drive Keypad & Display Overview.....	59
9.1.3	6901 Remote Keypad & Display Overview.....	60
9.1.4	Keypad Menu Navigation Examples	62
9.1.5	Basic Drive Setup.....	62
9.2	'Remote' Operation (Using Pre-Defined Macro's)	70
9.2.1	Enable 'Remote' Control Mode	70
9.2.2	Selecting & Loading A Macro.....	70
9.2.3	Running The Drive.....	71
9.2.4	Application '1': Standard (Basic Speed Control).....	72
9.2.5	Application '2': Auto / Manual.....	73
9.2.6	Application '3': Presets	74
9.2.7	Application '4': Raise / Lower.....	75
9.2.8	Application '5': PID	76
9.2.9	Application '6': Aux Comms	77
10	Routine Maintenance & Repair	78
10.1	Routine Maintenance	78
10.2	Preventative Maintenance	78
10.2.1	Main Duct Cooling Fans	78
10.2.2	DC Link Capacitors.....	78
10.3	Repair.....	78
11	Compliance	79
11.1	Applicable Standards	79
11.2	European Compliance	79
11.2.1	CE Marking.....	79
11.2.2	EMC Compliance.....	81
11.2.3	EMC Standards.....	81
11.2.4	EMC Installation Guidance	88
11.2.5	Harmonic Information	94
11.3	North American & Canadian Compliance	103
11.3.1	North American Compliance.....	103
11.3.2	Canadian Compliance	103
11.3.3	North American & Canadian Compliance Information	103
11.4	Environmental Compliance	104
11.4.1	REACH (Restriction, Evaluation, Authorisation & Restriction of Chemicals).....	104
11.4.2	RoHS (Restriction of Hazardous Substances)	104
11.4.3	WEEE (Waste Electrical & Electronic Equipment).....	105
12	AC15 Series Product Codes.....	106
13	Technical Information.....	107

13.1	General Product Ratings.....	107
13.1.1	Environment.....	107
13.1.2	Safety.....	107
13.1.3	Earthing.....	107
13.1.4	Mains Supply.....	107
13.2	AC Line Fed Power Stack Ratings.....	108
13.2.1	1 ϕ , 230V Products.....	108
13.2.2	3 ϕ , 230V Products.....	108
13.2.3	3 ϕ , 480V Products.....	108
13.3	Internal Brake Switch Ratings.....	109
13.3.1	1 ϕ , 230V Products.....	109
13.3.2	3 ϕ , 230V Products.....	109
13.3.3	3 ϕ , 480V Products.....	110
13.4	Control Board Ratings.....	110
13.4.1	Analogue Inputs.....	110
13.4.2	Analogue Outputs.....	111
13.4.3	Digital Inputs.....	111
13.4.4	High Speed Digital Inputs.....	112
13.4.5	Digital Outputs.....	112
13.4.6	Relay Outputs.....	112
13.4.7	Motor Thermistor Input.....	112
13.4.8	User +24V Output.....	113
13.4.9	External +24V Auxiliary Input.....	113
13.4.10	STO Inputs.....	113
Appendix A: Power Stack Circuit Overview		114
	1 ϕ , 230V Products.....	114
	3 ϕ , 230V Products.....	115
	3 ϕ , 480V Products.....	117

4 Introduction

4.1 About this Hardware Installation Manual

4.1.1 Users

This Manual is intended for use by the installer of the AC15 series Drive. It assumes a reasonable level of understanding in this discipline.

There is a separate Software Reference Manual – DOC-0017-05 “AC15 Series - Software Reference Manual”, that is intended for use by the user and programmer of the AC15 series Drive.

4.1.2 Manual Organization

This Hardware Installation Manual is organized into chapters, indicated by the numbering on the edge of each page.

If the manual is to be printed, it is designed so that it should be printed double-sided using the long-edge for binding.

The Manual is ordered in a sequence that takes the user through the product installation process, resulting in the basic operation of the drive.

Information for the full AC15 product is referred to as “the drive” throughout the manual.

Product coding: Any “x” within a product code indicates there are variants. See ‘Chapter 12: AC15 Series Product Codes’ section for more information.

4.1.3 Manual Revision

This revision replaces all previous revisions of this document. Parker has made every effort to ensure that this document is complete and accurate at the time of printing. In accordance with our policy of continuous product improvement, all data in this document is subject to change or correction without prior notice.

4.2 Before You Start...

4.2.1 Equipment Inspection

At the point of receipt of your product, check:

- For signs of transit damage.
- That the product code on the box label matches your order.

4.2.2 Equipment Storage

If the product is not being installed immediately, store the unit:

- In a well-ventilated place.
- Away from high temperatures and humidity,
- Away from dust or metal particles.

Storage Temperature:	-25°C to 55°C
Shipping Temperature:	-25°C to 70°C

4.2.3 Initial Steps

Use this Hardware Installation Manual to help plan the following:

1. Installation

Know your requirements:

- Certification, i.e. CE, UL, CUL compliance (Chapter 11: Compliance).
- Conformance to local installation requirements.
- Supply and Cabling requirements (Chapter 6: Installation).

2. Motor Considerations

It is important to consider that:

- The motor used with the Drive is suitable for Drive duty.
- The rated current of the motor used with the Drive is not less than 25% of the Drive current rating. If this is the case, poor motor control or autotune problems may occur.

4.2.4 Unpacking the Product

When unpacking the product:

- Save the packaging. In case of the need to return the product, improper packaging can result in transit damage.
- Use safe and suitable lifting procedure when moving the unit. Never lift the unit by its terminal connections.
- Prepare a clear, flat surface to receive the drive before attempting to move it. Do not damage any terminal connections when putting the unit down.
- Refer to 'Chapter 6: Installation' for further details on handling the products.

5 Product Overview



General Overview:	
Power Range:	0.5 - 40 HP
Frame Sizes:	5 (Frames 1 – 5)
Power Supply:	1ø 220 – 240Vac ±10%, (Frames 1 - 2: 0.5 - 3 HP) 3ø 220 – 240Vac ±10%, (Frames 1 - 5: 0.5 - 15 HP) 3ø 380 – 480Vac ±10%, (Frames 1 - 5: 0.5 – 40 HP)
Input Frequency:	50/60Hz ±10%
Output Frequency:	0.5 – 590Hz
Safe Torque Off (STO):	SIL2, PLd
Environment:	<p>Temperature:</p> <p>Frame 1, 1ø 230V, 0.5 HP (Fan-less):</p> <ul style="list-style-type: none"> - 0 - 40°C <p>All other products:</p> <ul style="list-style-type: none"> - 0 - 40°C (derate output current above 40°C by 2% per °C, up to maximum of 45°C) <p>Altitude:</p> <p>0 – 1000m (derate output current above 1000m by 1% per 100m, up to maximum of 2000m)</p>

General Power Stack Features:	
Switching Frequency:	Minimum: 1kHz Default: 4kHz Maximum: 10kHz Linear derating of output current will apply above the default switching frequency (varies by power rating. Refer to Chapter 13: Technical Information for values).
Output Frequency:	Induction Motors: <ul style="list-style-type: none"> - Maximum = Switching Frequency 8 PMAC Motors: <ul style="list-style-type: none"> - Maximum = Switching Frequency 6 Note: Output frequency is limited to a maximum frequency of 590Hz due to export rules.
Duty Rating:	Heavy Duty (HD)
Power Stack Protection Features:	
Trip Conditions:	Output Short Circuit Overcurrent: 220% Rated Output Current Motor Stall Overvoltage / Undervoltage: <ul style="list-style-type: none"> - 230V products = 420Vdc / 220Vdc - 480V products = 840Vdc / 410Vdc Heatsink Overtemperature Motor Thermistor Overtemperature Three Phase OK (Missing Line Phase Detection): <ul style="list-style-type: none"> - 3ϕ 230V products: Frames 3 – 5 only - 3ϕ 480V products: Frames 4 & 5 only
Current Limit:	Adjustable up to 150%
Overload Rating:	150% for 60s (Inverse Time / Motor I*t)
User Terminals:	
Line Input:	3x Three phase / 2x Single phase AC input terminals: L1/L, L2/N, L3
Motor Output:	3x AC output terminals: U, V, W
Brake Output:	2x DC output terminals: DC+, DBR
PE:	Minimum of 2x Protective earth connections
General Control Features:	
Motor Control Modes:	Induction Motors: <ul style="list-style-type: none"> - V/F Control (V/Hz) - Sensorless Vector Control PMAC Motors: <ul style="list-style-type: none"> - Sensorless Vector Control
Voltage Boost for V/F Control:	0-25%
Skip Frequencies:	Skip frequencies with adjustable skip band width
Preset Speeds:	User selectable preset speeds
Stopping Modes:	Ramp, Coast, DC Injection, Fast Stop
Linear & S Ramps:	Symmetric or asymmetric ramp up and down rates
Raise/Lower:	Programmable Motorized Potentiometer (MOP) function
Jog:	Programmable jog speed

Diagnostics:	Real-time drive feedback monitoring and fault diagnostics
Base Control Board I/O:	
Analogue Inputs:	<p>Frame 1:</p> <ul style="list-style-type: none"> - 2x Configurable Inputs: Voltage Mode (0-10V) / Current Mode (0-20mA, 4-20mA) <p>Frames 2 – 5:</p> <ul style="list-style-type: none"> - 2x Configurable Inputs: Voltage Mode ($\pm 10V$, 0-10V) / Current Mode (0-20mA, 4-20mA)
Analogue Outputs:	<p>Frame 1:</p> <ul style="list-style-type: none"> - 2x Configurable Outputs: 2x Voltage Mode (0-10V) / Current Mode (0-20mA) <p>Frames 2 – 5:</p> <ul style="list-style-type: none"> - 3x Configurable Outputs: 2x Voltage Mode (0-10V) / Current Mode (0-20mA), 1x Voltage Mode ($\pm 10V$, 0-10V)
Digital Inputs:	<p>Frames 1:</p> <ul style="list-style-type: none"> - Up to 6x Configurable 24Vdc Inputs (4x Dedicated Inputs with common selectable pull-ups for active low operation) <p>Frames 2 – 5:</p> <ul style="list-style-type: none"> - Up to 8x Configurable 24Vdc Inputs (6x Dedicated Inputs with common selectable pull-ups for active low operation)
Digital Outputs:	Up to 2x Configurable 24Vdc Outputs
Relay Outputs:	1x Configurable Relay Outputs
User +24V Output:	1x User +24V Reference Voltage Output
External +24V Auxiliary Input:	1x +24Vdc Input (PELV)
Base Communication Ports:	
Ethernet:	<p>1x RJ45 Port</p> <p>Frame 1:</p> <ul style="list-style-type: none"> - DSELite / Web HTTP Server / Modbus TCP <p>Frames 2 – 5:</p> <ul style="list-style-type: none"> - DSELite / Web HTTP Server / Modbus TCP / EtherNet/IP
RS232:	1x RJ11 Port for remote 6901 MMI

6 Installation



IMPORTANT

Please ensure that you have read and are familiar with the 'Compliance' chapter before installing the unit.



6.1 Mechanical

6.1.1 Product Dimensions & Weights

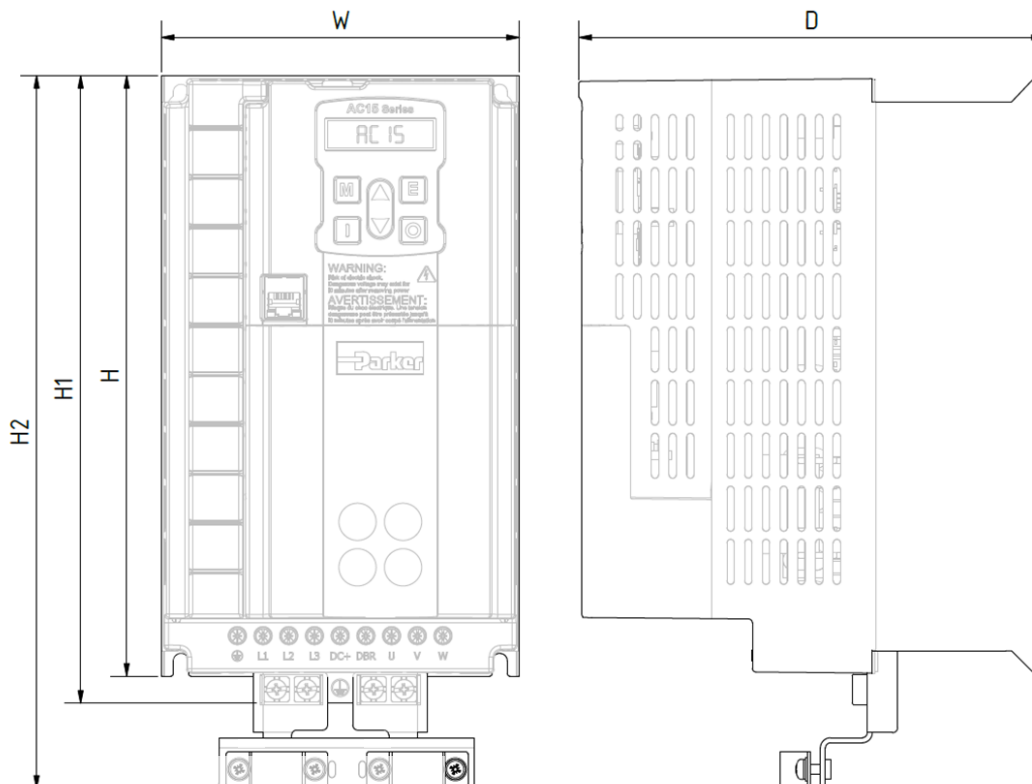

Optional Wiring Bracket shown for reference only

Frame Size	Product Dimensions					Weight
	H	H1	H2	W	D	
1	138.0 (5.43)	151.0 (5.94)	175.1 (6.89)	81.5 (3.21)	144.3 (5.68)	1.1 (2.43)
2	180.0 (7.09)	193.0 (7.60)	227.5 (8.96)	108.4 (4.27)	185.0 (7.28)	2.0 (4.41)
3	237.5 (9.35)	248.0 (9.76)	281.9 (11.10)	141.6 (5.57)	184.0 (7.24)	3.3 (7.28)
4	265.0 (10.43)	283.0 (11.14)	321.4 (12.65)	161.0 (6.34)	196.0 (7.72)	4.4 (9.70)
5	340.0 (13.39)	358.0 (14.09)	401.4 (15.80)	210.0 (8.27)	220.2 (8.67)	8.0 (17.64)

All dimensions in millimeters (*inches*)

All weights in kilograms (*lbs*)

6.1.2 Product Fixing Dimensions

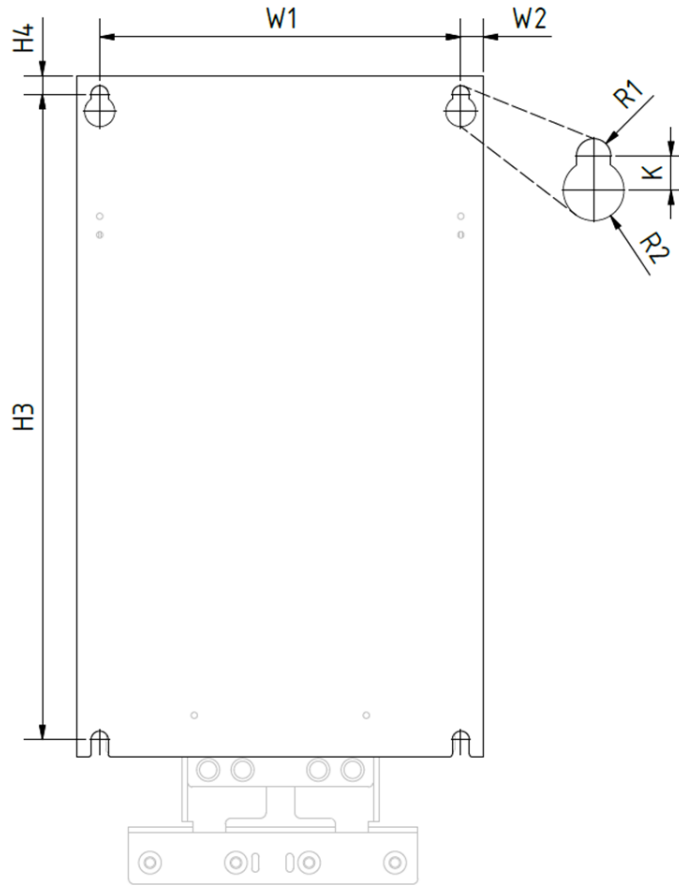

Frame Size	Fixing Dimensions				Slot Size			Fixings
	H3	H4	W1	W2	K	R1	R2	
1	128.0 (5.04)	5.0 (0.20)	70.0 (2.76)	5.7 (0.22)	5.0 (0.20)	2.3 (0.09)	4.7 (0.19)	M4
2	170.0 (6.69)	5.0 (0.20)	94.0 (3.70)	7.2 (0.28)	5.0 (0.20)	2.3 (0.09)	4.7 (0.19)	M4
3	225.0 (8.86)	6.5 (0.26)	126.0 (4.96)	7.8 (0.31)	6.0 (0.24)	3.0 (0.12)	5.3 (0.21)	M5
4	255.0 (10.04)	5.0 (0.20)	146.0 (5.75)	7.5 (0.30)	5.0 (0.20)	2.5 (0.10)	4.6 (0.18)	M5
5	329.0 (12.95)	5.5 (0.22)	194.0 (7.64)	8.0 (0.31)	6.0 (0.24)	3.0 (0.12)	5.5 (0.22)	M5

All dimensions in millimeters (inches)

6.1.3 Lifting the Drive

These products can be lifted by an individual. Care must be taken when handling the products to avoid injury.

6.1.4 Mounting the Drive

These products are intended to be mounted vertically inside a suitable enclosure.



1. Mark out the fixing hole positions on the cubicle back panel as per the Fixing Dimensions listed in the table above.
2. Drill the fixing holes as per the Slot Size and required Fixing as listed in the table above.
3. Screw the fixings part way into the cubicle back panel.
4. Lift the drive into position and onto the fixings using the keystone slots at the top of the product to hang the drive into position.
5. Secure the product by fully tightening the fixings.
6. The drive is now ready for wiring.

6.1.5 Ventilation Clearance Requirements

The drive gives off heat in normal operation and must therefore be mounted to allow the free flow of air through the ventilation slots and heatsink:

- Maintain minimum clearances for ventilation as given in the tables below to ensure adequate cooling of the drive, and that heat generated by other adjacent equipment is not transmitted to the drive.
- Be aware that other equipment may have its own clearance requirements.
- When mounting two or more drive together, these clearances are additive.
- Ensure that the mounting surface is normally cool.
- The drive must be mounted in a suitable cubicle.

Minimum Air Clearance for Product:

Frame 3 is shown for illustration only.

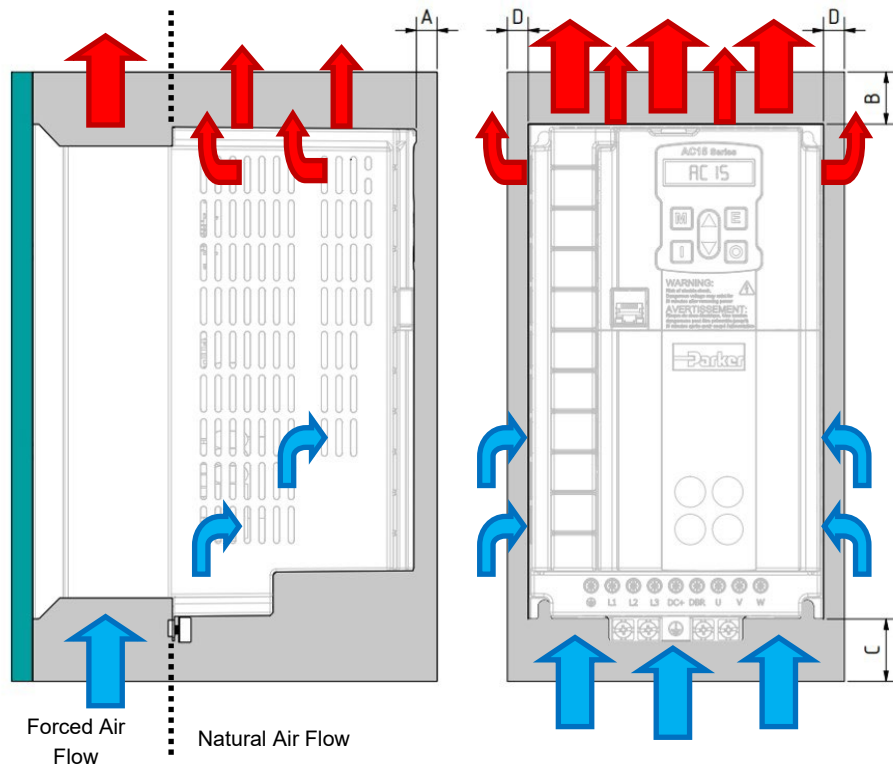

Frame Size	Product Clearances			
	A	B	C	D
1	10.0 (0.39)	150.0 (5.91)	150.0 (5.91)	50.0 (1.97)
2	10.0 (0.39)	150.0 (5.91)	150.0 (5.91)	50.0 (1.97)
3	10.0 (0.39)	150.0 (5.91)	150.0 (5.91)	50.0 (1.97)
4	10.0 (0.39)	150.0 (5.91)	150.0 (5.91)	50.0 (1.97)
5	10.0 (0.39)	150.0 (5.91)	150.0 (5.91)	50.0 (1.97)

All dimensions in millimeters (inches)

Note: The optional wiring bracket does not affect the clearance dimension below the product (dimension C).

6.1.6 Wiring Bracket (Optional)

Optional wiring brackets are available for the AC15 product range. These brackets support the cabling to and from the drive, as well as providing a convenient means to achieve a 360° connection to the cable screen.

Order Codes

Order Code	Description
ASP-0039-01	AC15 Wiring Bracket Kit - Frame 1
ASP-0039-02	AC15 Wiring Bracket Kit - Frame 2
ASP-0039-03	AC15 Wiring Bracket Kit - Frame 3, 480V
ASP-0039-04	AC15 Wiring Bracket Kit - Frame 4, 480V
ASP-0039-05	AC15 Wiring Bracket Kit - Frame 5, 480V
ASP-0039-06	AC15 Wiring Bracket Kit - Frame 3, 230V
ASP-0039-07	AC15 Wiring Bracket Kit - Frame 4, 230V
ASP-0039-08	AC15 Wiring Bracket Kit - Frame 5, 230V

ASP-0039-01



ASP-0039-02



ASP-0039-03



ASP-0039-04



ASP-0039-05



ASP-0039-06



ASP-0039-07



ASP-0039-08



Installation

The Wiring Brackets mount to the chassis earthing points using the clamps and fixings pre-installed to the drive. Frame 2 is shown for illustration only:

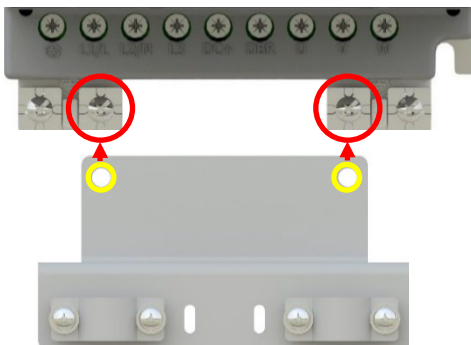

1. Unscrew and remove the necessary chassis PE clamps.
2. Align and place the wiring bracket onto the bare chassis PE tabs.

3. Secure the wiring bracket to the chassis with the previously removed clamps and screws (from step 1).



For the Frame 3, 4 & 5 230V products:

1. Remove the fixings of the 'L' brackets (with the earth clamps attached), from the heatsink.
2. Replace the 'L' brackets with the wiring bracket, reusing the heatsink fixings.
3. Move the earth clamps across from the 'L' brackets and fit onto the wiring bracket.

6.2 Electrical



IMPORTANT



Please ensure that you have read and are familiar with the 'Safety' chapter before proceeding with the electrical installation.



DANGER!

RISK OF ELECTRIC SHOCK



Terminal covers, main covers, and cover fixings must remain in place while the drive is energized.

These should only ever be removed once the supply to the unit and/or system has been disconnected, and the residual energy in the DC link capacitors has been discharged.

- **All activities covered in this chapter should be carried out when there is no power to the drive.**
- **If the drive has been powered up, ensure enough time has elapsed that the drive has discharged its residual energy.**
- **Always check that the voltages on the user terminals are at a safe level (<50V) before carrying out any of these activities.**

- **STO always overrides any attempt to start the drive. If one or both STO control inputs is requesting the STO function, the drive will not start.**
- **Refer to 'Chapter 8: Safe Torque Off (STO): SIL2, PLd' for further information.**

6.2.1 Power Stack Wiring

Terminal Identification

Frame 1:



Label	Description
L3 / PE	Supply Input Phase L3 / Protective Earth
L2 / N	Supply Input Phase L2 / Neutral
L1 / L	Supply Input Phase L1 / Live
DC+	DC+ / Dynamic Brake Resistor Connection (+)
DBR	Dynamic Brake Resistor Connection (-)
U	Motor Output Phase U
V	Motor Output Phase V
W	Motor Output Phase W

Note: Access to terminals DC+ and DBR is blocked by a plastic cutout to prevent accidental incorrect connections. To connect a braking resistor, snip the tabs on either side of the cutout using angled cutters with the power OFF. Wait 5 minutes if the drive was energized earlier.

Frame 2:

Label	Description
PE	Protective Earth
L1 / L	Supply Input Phase L1 / Live
L2 / N	Supply Input Phase L2 / Neutral
L3	Supply Input Phase L3
DC+	DC+ / Dynamic Brake Resistor Connection (+)
DBR	Dynamic Brake Resistor Connection (-)
U	Motor Output Phase U
V	Motor Output Phase V
W	Motor Output Phase W

Note: Access to terminals DC+ and DBR is blocked by a plastic cutout to prevent accidental incorrect connections. To connect a braking resistor, snip the tabs on either side of the cutout using angled cutters with the power OFF. Wait 5 minutes if the drive was energized earlier.

Frames 3 & 4:

Label	Description
PE	Protective Earth
L1	Supply Input Phase L1
L2	Supply Input Phase L2
L3	Supply Input Phase L3
DC+	DC+ / Dynamic Brake Resistor Connection (+)
DBR	Dynamic Brake Resistor Connection (-)
U	Motor Output Phase U
V	Motor Output Phase V
W	Motor Output Phase W

Note: Access to terminals DC+ and DBR is blocked by a plastic cutout to prevent accidental incorrect connections. To connect a braking resistor, snip the tabs on either side of the cutout using angled cutters with the power OFF. Wait 5 minutes if the drive was energized earlier.

Frame 5:

Label	Description
PE	Protective Earth
L1	Supply Input Phase L1
L2	Supply Input Phase L2
L3	Supply Input Phase L3
DC+	DC+ / Dynamic Brake Resistor Connection (+)
DC-	DC- (Drive not designed for common bussing)
DBR	Dynamic Brake Resistor Connection (-)
U	Motor Output Phase U
V	Motor Output Phase V
W	Motor Output Phase W

Note: Access to terminals DC+ and DBR is blocked by a plastic cutout to prevent accidental incorrect connections. To connect a braking resistor, snip the tabs on either side of the cutout using angled cutters with the power OFF. Wait 5 minutes if the drive was energized earlier.

Drive Connections

AC Line Input Connections:

Incoming AC line supply connections should be wired into terminals:

- L 'Live' & N 'Neutral' on single phase products (15G-1x-...)
- L1, L2 & L3 on three phase products (15G-3x-... & 15G-4x-...)

On three phase products, phase rotation is not critical.

AC Motor Output Connections:

Output motor supply connections should be wired into terminals U, V & W.

Phase rotation is critical to ensure consistency between the drive motor control direction and motor shaft rotation.

The motor direction can be inverted electronically by setting the '**IM Wiring**' parameter (0182) to '**1**' (**TRUE**). This swaps output phases V & W in the drive firmware. Refer to 'Chapter 9: Basic Drive Operation'.

Potential Earth (PE) Connections:

Connect both the drive incoming supply earth cable and motor earth cable to the drive PE terminals.

DC Dynamic Brake Output Connections:

Where a Dynamic Brake Resistor (DBR) is required for an drive application, connect the resistor across terminals DC+ & DBR.

Wiring Example

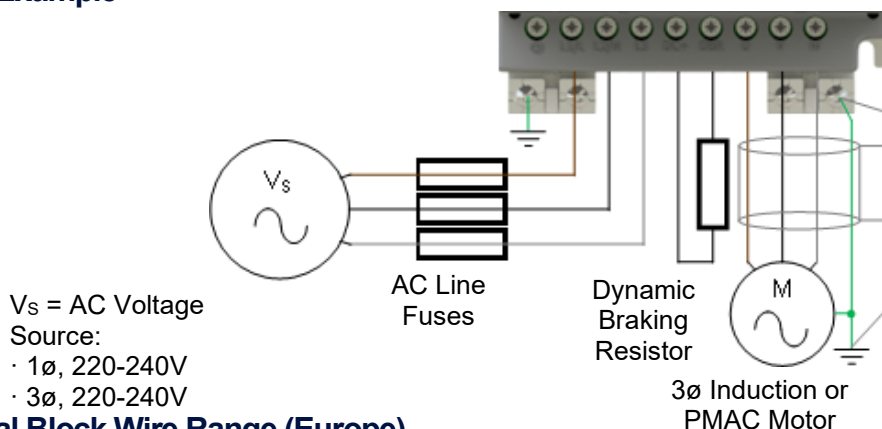

Terminal Block Wire Range (Europe)

Wire sizes for Europe should be chosen with respect to the drive operating conditions, in addition to local National Electrical Safety Installation Requirements. Local wiring regulations always take precedence.

230V Products:

Frame Size	AC Line Input Terminals (L1/L, L2/N, L3)	DC Link / Brake Output Terminals (DC+, DC-, DBR)	Motor Output Terminals (U, V, W)	Earth Terminal (PE)	Chassis Earth Clamp (PE)
1			0.5 – 2.5		M4 Fork Crimp
2			1.5 – 4.0		M4 Fork Crimp
3			4.0 – 10.0		M4 Fork Crimp
4			0.5 – 10.0		M4 Fork Crimp
5			0.5 – 35.0		M4 Fork Crimp

All cable size ranges specified in mm²

480V Products:

Frame Size	AC Line Input Terminals (L1/L, L2/N, L3)	DC Link / Brake Output Terminals (DC+, DC-, DBR)	Motor Output Terminals (U, V, W)	Earth Terminal (PE)	Chassis Earth Clamp (PE)
1			1.5 – 4.0		M4 Fork Crimp
2			1.5 – 4.0		M4 Fork Crimp
3			4.0 – 10.0		M4 Fork Crimp
4			0.5 – 10.0		M4 Fork Crimp
5			0.5 – 35.0		M5 Fork Crimp

All cable size ranges specified in mm²

Terminal Block Wire Range (North America)

North American wire sizes (AWG) are based on NEC/NFPA-70 for ampacities of thermoplastic-insulated (75°C) copper conductors.

The wire sizes allow for an ampacity of 125% of the rated input and output amperes for motor branch-circuit conductors as specified in NEC/NFPA-70.

1 \emptyset , 230V Products:

Frame Size	Product Code	Motor Power (HP)	AC Line Input Terminals (L1/L, L2/N, L3)	Brake Output Terminals (DC+, DBR)	Motor Output Terminals (U, V, W)
1	Terminal Block Wire Range: 12 – 26 AWG				
	15G-11-0025...	0.5	14	14	14
	15G-11-0045...	1	14	14	14
	15G-11-0070...	2	14	14	14
2	Terminal Block Wire Range: 10 – 26 AWG				
	15G-12-0100...	3	10	14	10

All cable sizes specified in AWG

3 \emptyset , 230V Products:

Frame Size	Product Code	Motor Power (HP)	AC Line Input Terminals (L1/L, L2/N, L3)	DC Link / Brake Output Terminals (DC+, DC-, DBR)	Motor Output Terminals (U, V, W)
1	Terminal Block Wire Range: 12 – 26 AWG				
	15G-31-0025...	0.5	14	14	14
	15G-31-0045...	1	14	14	14
	15G-31-0070...	2	14	14	14
2	Terminal Block Wire Range: 10 – 26 AWG				
	15G-32-0100...	3	14	14	14
3	Terminal Block Wire Range: 10 – 20 AWG				
	15G-33-0170...	5	10	14	10
4	Terminal Block Wire Range: 6 – 20 AWG				
	15G-34-0210...	7.5	10	14	10
5	Terminal Block Wire Range: 2 – 20 AWG				
	15G-35-0300...	10	8	12	8
	15G-35-0400...	15	8	10	8

All cable sizes specified in AWG

3 \emptyset , 480V Products:

Frame Size	Product Code	Motor Power (HP)	AC Line Input Terminals (L1/L, L2/N, L3)	DC Link / Brake Output Terminals (DC+, DC-, DBR)	Motor Output Terminals (U, V, W)
1	Terminal Block Wire Range: 10 – 30 AWG				
	15G-41-0012...	0.5	14	14	14
	15G-41-0020...	1	14	14	14
	15G-41-0040...	2	14	14	14
2	Terminal Block Wire Range: 10 – 30 AWG				
	15G-42-0065...	3	14	14	14
	15G-42-0090...	5	14	14	14
3	Terminal Block Wire Range: 10 – 20 AWG				
	15G-43-0120...	7.5	12	14	14
	15G-43-0170...	10	10	14	10
4	Terminal Block Wire Range: 6 – 20 AWG				
	15G-44-0230...	15	10	14	10
	15G-44-0320...	20	8	14	8
5	Terminal Block Wire Range: 2 – 20 AWG				
	15G-45-0380...	25	6	10	8
	15G-45-0440...	30	6	10	6
	15G-45-0600...	40	3	8	4

All cable sizes specified in AWG

Terminal Block Tightening Torques

230V Products:

Frame Size	AC Line Input Terminals (L1/L, L2/N, L3)	DC Link / Brake Output Terminals (DC+, DC-, DBR)	Motor Output Terminals (U, V, W)	Earth Terminal (PE)	Chassis Earth Clamp (PE)
1			0.4 (3.5)		1.8 (16.0)
2			1.10 (9.7)		1.8 (16.0)
3			1.26 (11.2)		1.8 (16.0)
4			2.15 (19.0)		1.8 (16.0)
5			4.1 (36.3)		1.8 (16.0)

All torques are maximum values specified in Nm (*lb-in*)

480V Products:

Frame Size	AC Line Input Terminals (L1/L, L2/N, L3)	DC Link / Brake Output Terminals (DC+, DC-, DBR)	Motor Output Terminals (U, V, W)	Earth Terminal (PE)	Chassis Earth Clamp (PE)
1			1.13 (10.0)		1.8 (16.0)
2			1.13 (10.0)		1.8 (16.0)
3			1.26 (11.2)		1.8 (16.0)
4			2.15 (19.0)		1.8 (16.0)
5			4.1 (36.3)		3.6 (32.0)

All torques are maximum values specified in Nm (*lb-in*)

Cable Connections With Wiring Bracket Fitted

Below is an example of how to correctly terminate the motor screen onto the wiring bracket:

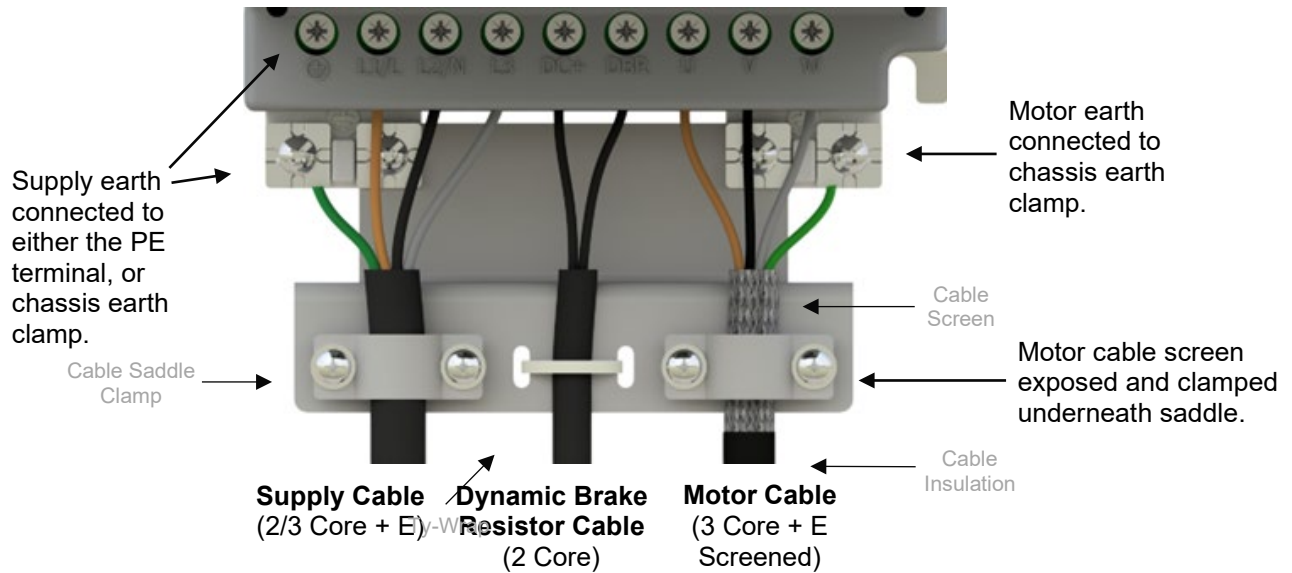

Y-Capacitors & VDR Earth Disconnects

The AC15 products are fitted with EMC filter capacitors connected between 'live' AC Line (and in some instances DC Link) circuits to earth. These capacitors are referred to as Y-Capacitors.

In some system applications where RCD's are in circuit, or where the drive is connected on an IT or open delta supply, these Y-Capacitors may need to be disconnected from earth. Removable links are provided to enable users to perform this task.

By default:

- AC Line Y-Caps are connected to earth ('EMC' connector 'J1', is fitted in position 1 – 3).
- DC Link Y-Caps are connected to earth ('P -> PE' connector 'J2' is fitted in position 1 – 3).

Most products are also fitted with input line voltage suppression devices connected between 'live' AC Line circuits to earth. These suppression devices are referred to as VDRs.

In some system applications where the product is exposed to large, transient voltage events on the power supply that it is connected to, it is recommended that the VDRs are connected to earth as a means of protecting the drives input rectification stage. Removable links are provided to enable users to perform this task.

By default:

- VDRs are **NOT** connected to earth ('VAR' connector 'Y1', is fitted in position 2 – 4).

A summary of links fitted to each product is shown below:

1ø, 230V Products:

Frame Size	Product Code	Motor Power (HP)	J1 'EMC' (AC Line Y-Cap) Link:	Y1 'VAR' (VDR) Link:	J2 'P -> PE' (DC Link Y-Cap) Link:
1	15G-11-0025...	0.5	✓	✗	✗
	15G-11-0045...	1	✓	✗	✗
	15G-11-0070...	2	✓	✗	✗
2	15G-12-0100...	3	✓	✗	✗

3ø, 230V Products:

Frame Size	Product Code	Motor Power (HP)	J1 'EMC' (AC Line Y-Cap) Link:	Y1 'VAR' (VDR) Link:	J2 'P -> PE' (DC Link Y-Cap) Link:
1	15G-31-0025...	0.5	✓	✓	✗
	15G-31-0045...	1	✓	✓	✗
	15G-31-0070...	2	✓	✓	✗
2	15G-32-0100...	3	✓	✓	✗
3	15G-33-0170...	5	✓	✗	✓
4	15G-34-0210...	7.5	✓	✗	✗
5	15G-35-0300...	10	✓	✗	✗
	15G-35-0400...	15	✓	✗	✗

3ø, 480V Products:

Frame Size	Product Code	Motor Power (HP)	J1 'EMC' (AC Line Y-Cap) Link:	Y1 'VAR' (VDR) Link:	J2 'P -> PE' (DC Link Y-Cap) Link:
1	15G-41-0012...	0.5	✓	✓	✗
	15G-41-0020...	1	✓	✓	✗
	15G-41-0040...	2	✓	✓	✗
2	15G-42-0065...	3	✓	✓	✗
	15G-42-0090...	5	✓	✓	✗
3	15G-43-0120...	7.5	✓	✓	✗
	15G-43-0170...	10	✓	✓	✗
4	15G-44-0230...	15	✓	✓	✗
	15G-44-0320...	20	✓	✓	✗
5	15G-45-0380...	25	✓	✓	✗
	15G-45-0440...	30	✓	✓	✗
	15G-45-0600...	40	✓	✓	✗

Approximate Link Locations:

Note: Link positions vary slightly between products. Image shows approximate link locations:

J1 'EMC' AC
Line Y-Cap &
Y1 'VAR'
VDR Links



To access the links, it is necessary to open the product:

- Remove:
 - Frame 1: 3x Power Stack cover fixings (1x top, 2x bottom) from the product
 - Frames 2 – 5: 4x Power Stack cover fixings (2x top, 2x bottom) from the product.
- Carefully lift the power stack cover with the control module attached - just enough to adjust the link positions. Removing the link completely is the same as placing the links in the 'disconnected' (pin 2 – 4) position.

Note: All power cables must be removed from the product to access the links.

6.2.2 Control Board Wiring

DANGER!

RISK OF ELECTRIC SHOCK



Terminal covers, main covers, and cover fixings must remain in place while the drive is energised.

These should only ever be removed once the supply to the unit and/or system has been disconnected, and the residual energy in the DC link capacitors has been discharged.



Terminal Cover Removal

The control module terminal cover must be removed to gain access to the control terminals for wiring.



1. Apply pressure to the center of the top edge of the terminal cover to disengage the retention clip.



2. Now slide the cover down and pull away from the control module.



To refit the terminal cover, perform the steps in reverse.

Terminal Identifications

Frame 1:

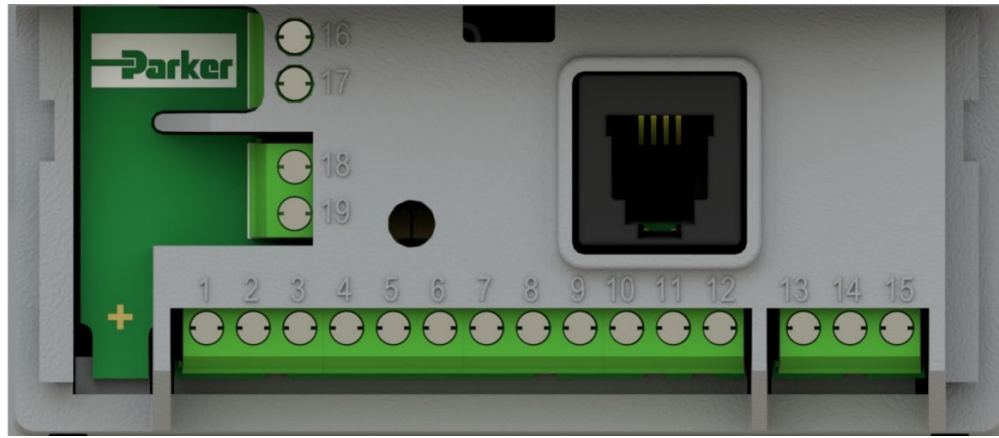

Terminal No.	Terminal Ident	Description
16	RL1A	Relay Output 1 (Contact A)
17	RL1B	Relay Output 1 (Contact B)
18	TH1	Motor Thermistor Input
19	TH2	Motor Thermistor Input
1	AI1	Analogue Input 1 ($\pm 10V$, 0-10V, 0-20mA, 4-20mA)
2	AI2	Analogue Input 2 ($\pm 10V$, 0-10V, 0-20mA, 4-20mA)
3	AO1	Analogue Output 1 (0-10V, 0-20mA, 4-20mA)
4	AO2	Analogue Output 2 (0-10V, 0-20mA, 4-20mA)
5	0V	0V Reference For Analogue & Digital I/O / External 0V Auxiliary Input
6	24V	User +24V Output / External +24V Auxiliary Input
7	DX1	Digital Input / Output 1 (24V Configurable)
8	DX2	Digital Input / Output 2 (24V Configurable)
9	DI3	Digital Input 3
10	DI4	Digital Input 4 / Encoder Channel A Input (High Speed)
11	DI5	Digital Input 5 / Encoder Channel B Input (High Speed)
12	DI6	Digital Input 6
13	STOA	STO Input Channel A
14	0V	STO 0V Reference
15	STOB	STO Input Channel B

Frames 2 – 5:

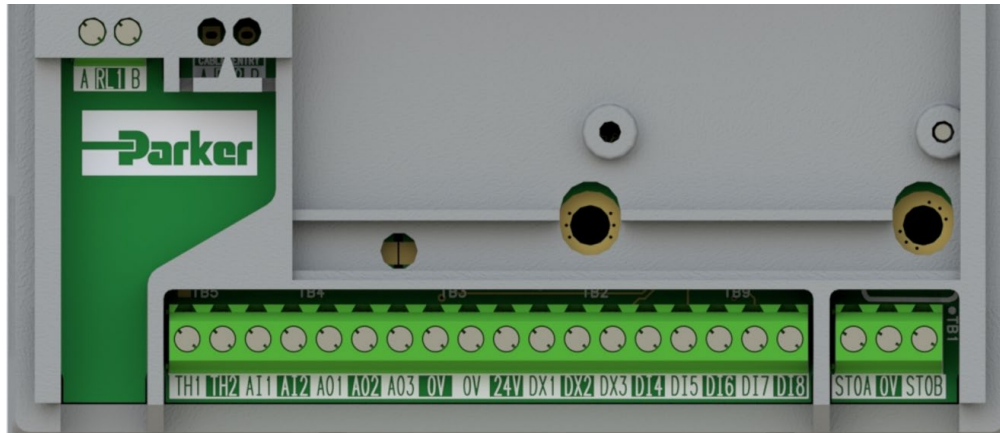

Terminal Ident	Description
RL1A	Relay Output 1 (Contact A)
RL1B	Relay Output 1 (Contact B)
TH1	Motor Thermistor Input
TH2	Motor Thermistor Input
AI1	Analogue Input 1 ($\pm 10V$, 0-10V, 0-20mA, 4-20mA)
AI2	Analogue Input 2 ($\pm 10V$, 0-10V, 0-20mA, 4-20mA)
AO1	Analogue Output 1 (0-10V, 0-20mA, 4-20mA)
AO2	Analogue Output 2 (0-10V, 0-20mA, 4-20mA)
AO3	Analogue Output 3 ($\pm 10V$, 0-10V)
0V	0V Reference For Analogue & Digital I/O
0V	0V Reference For Analogue & Digital I/O / External 0V Auxiliary Input
24V	User +24V Output / External +24V Auxiliary Input
DX1	Digital Input / Output 1 (24V Configurable)
DX2	Digital Input / Output 2 (24V Configurable)
DX3	Digital Input 3
D14	Digital Input 4 / Encoder Channel A Input (High Speed)
D15	Digital Input 5 / Encoder Channel B Input (High Speed)
D16	Digital Input 6
D17	Digital Input 7
D18	Digital Input 8
STOA	STO Input Channel A
0V	STO 0V Reference
STOB	STO Input Channel B

Wiring Example

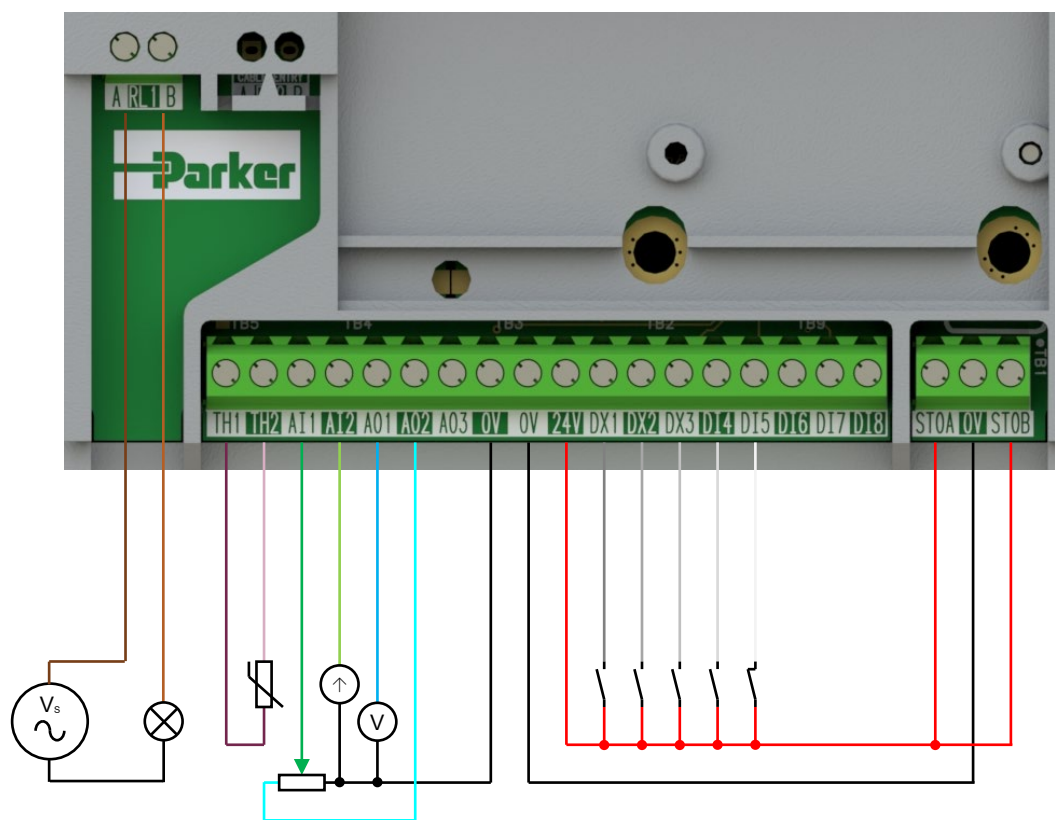

Configuration Setup:

RL1A	110-230Vac (or 24Vdc) voltage supply.
RL1B	Relay output (to lamp).
TH1	Motor Thermistor '+' connection.
TH2	Motor Thermistor '-' connection.
AI1	0-10V variable input (from potentiometer)
AI2	4-20mA variable input (from current source)
AO1	0-10V variable output (to voltmeter)
AO2	0-10V variable output (+10V fixed reference voltage)
DX1	24V digital input
DX2	24V digital input
DX3	24V digital input
DI4	24V digital input
DI5	24V digital input
STO	STO DISABLED (drive operational)

Terminal Block Wire Range

The control board terminal wire range is as follows:

Terminal Wire Range	
Min	Max
0.2mm ² (24 AWG)	1.0mm ² (18 AWG)

Wire sizes for Europe should be chosen with respect to the operating conditions and your local National Electrical Safety Installation Requirements. Local wiring regulations always take precedence.

Recommended Wire & Ferrule Sizes

The following wire sizes and ferrules are recommended for use with the control board terminal blocks:

Wire Type	Maximum Wire Size	Ferrule Details	Bare Wire / Ferrule Length
Stranded	1x 1.0mm ² (1x 18 AWG)	None Fitted	5mm (0.20")
	2x 0.5mm ² (2x 21 AWG)	None Fitted	
Stranded	1x 0.75mm ² (1x 19 AWG)	White Collar, 1.5mm OD	6mm (0.24")
	1x 0.5mm ² (1x 21AWG)	Orange Collar, 1.3mm OD	

Terminal Block Tightening Torque

The control board terminals should be screwed to a maximum torque as specified below:

Screw Head	Terminal Tightening Torque
M2, Flat	0.19 Nm (1.7 Lb-in)

6.2.3 Control Board Communications Wiring

The Ethernet communications socket allows users to:

- Communicate over Ethernet IP (Frames 2 – 5 only), or Modbus TCP/IP.
- Access the drive's Web Server.
- Connect to the Drive System Explorer (DSE Lite) software for function block programming of custom applications and firmware updates, etc.

Recommended Ethernet Cables

The following Ethernet cables are recommended for connecting to the control board RJ45 socket:

Ethernet Cable Category	Screened / Unscreened
CAT5e	Screened
CAT6	Screened

Cable Connection

The Ethernet cable plugs into the RJ45 socket on the front of the product:



To remove the cable, push the connector clip up towards the cable and pull away from the product.

6.3 μ SD Memory Card

Commercially available μ SD Memory Cards may be fitted to allow users to:

- Clone drive applications and archive files for duplication or copying to a replacement unit.
- Provide a quick and easy means of updating the drive firmware in the field.

Note: The μ SD card must be FAT32 formatted. This implies a 32GB limitation of MS Windows OS. If a different type of μ SD card is used, then a partition tool may be required.

6.3.1 Installation



WARNING!
RISK OF DATA CORRUPTION

Do not remove the μ SD card when reading or writing to the memory storage device. This could cause irreversible data corruption.



The μ SD Memory Card is intended to be customer installed.
 It is inserted in a slot on the top of the product:

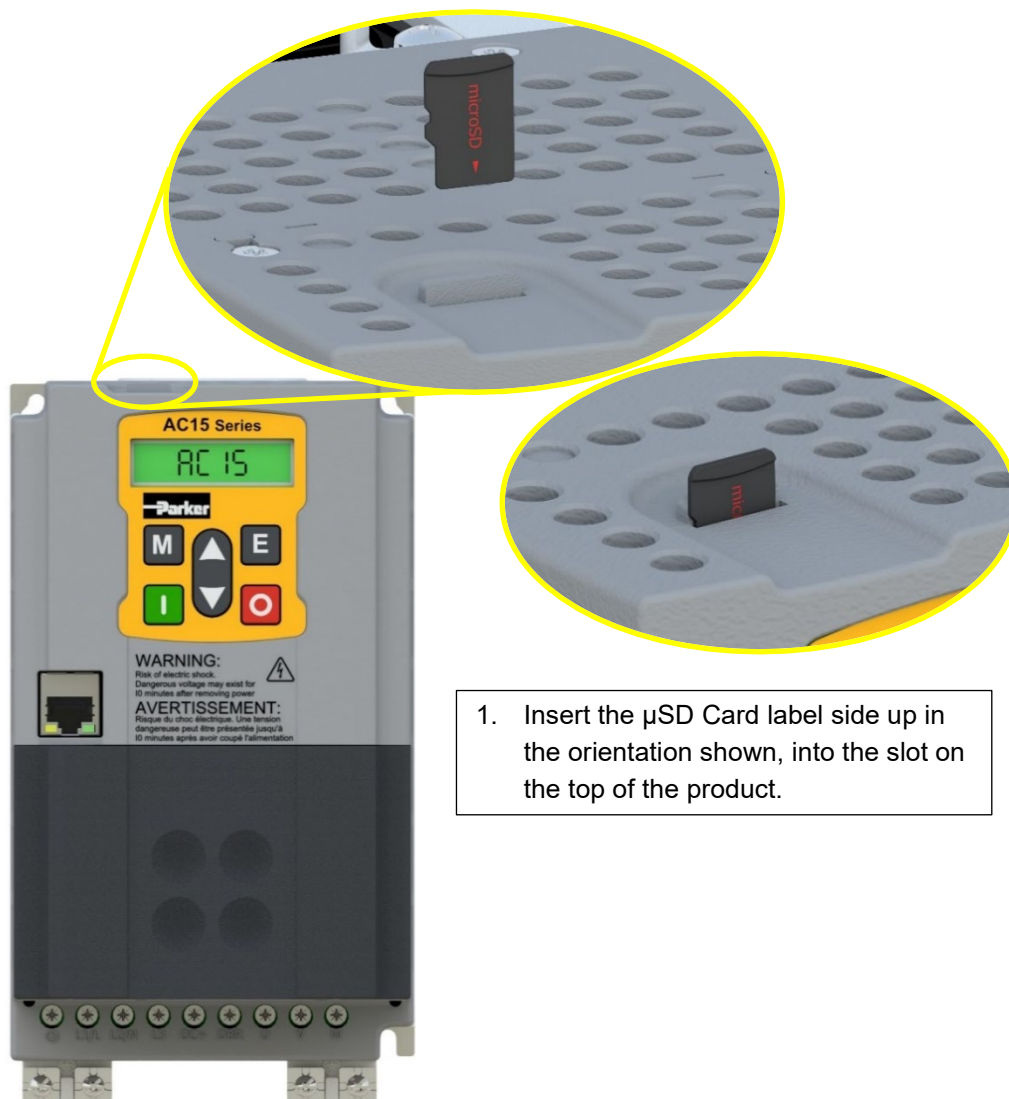

To remove the card, pull it up out of the slot.

6.4 Remote Mounted 6901 MMI

In addition to the Drive mounted keypad, there is a RJ11 port available to the user for connecting a remote mounted 6901 Keypad.



The 6901 can be useful when performing commissioning functions, or when a 6901 MMI is to be mounted remotely, i.e., on the door of a control cubicle.

6.4.1 Order Codes

Order Code	Description
6901-00-G	6901 Display Keypad
6052-00-G	6901 Remote Mounting Kit

6.4.2 Installation

The remote mounting kit (6052-00-G) is supplied with instructions and a 1-to-1 fixing template to be used during installation:

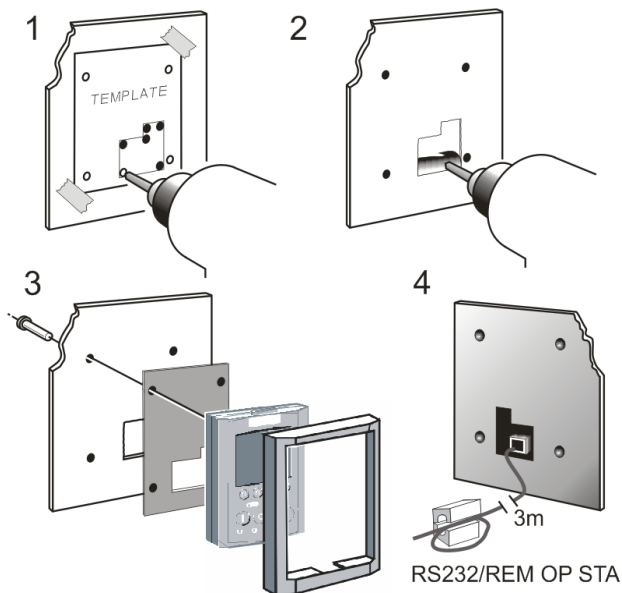
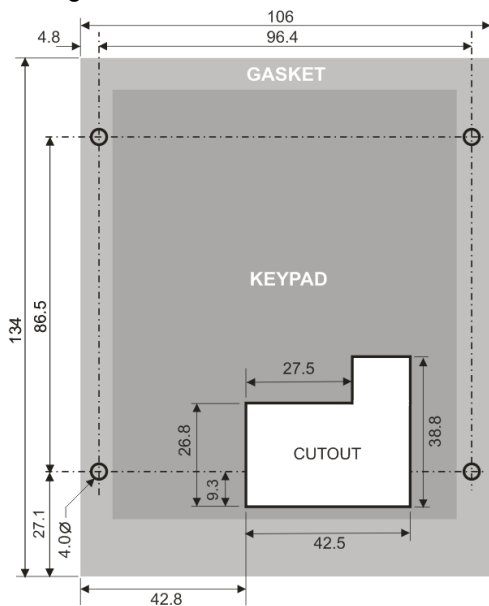

6.4.3 Cable Connection

The control module terminal cover will need to be removed prior to connecting the remote 6901 MMI cable.



To remove the cable, push the connector clip up towards the cable and pull away from the product.

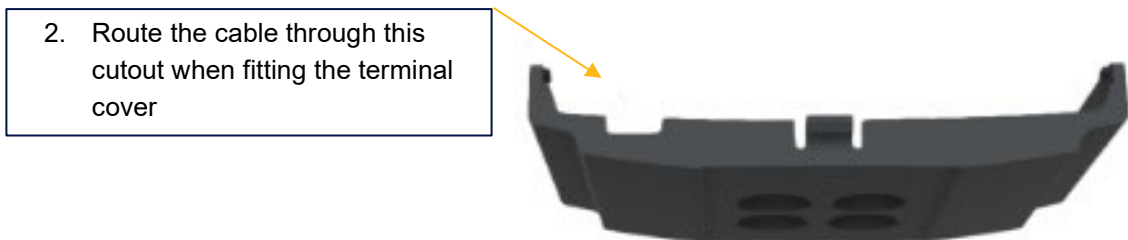

7 Associated Equipment

Additional mandatory equipment is required when installing an drive (i.e., AC Line Input Fuses), as well as optional components that may be specific to the installation (i.e., Input Chokes, EMC Filters, Output Chokes) as shown in the diagram below:

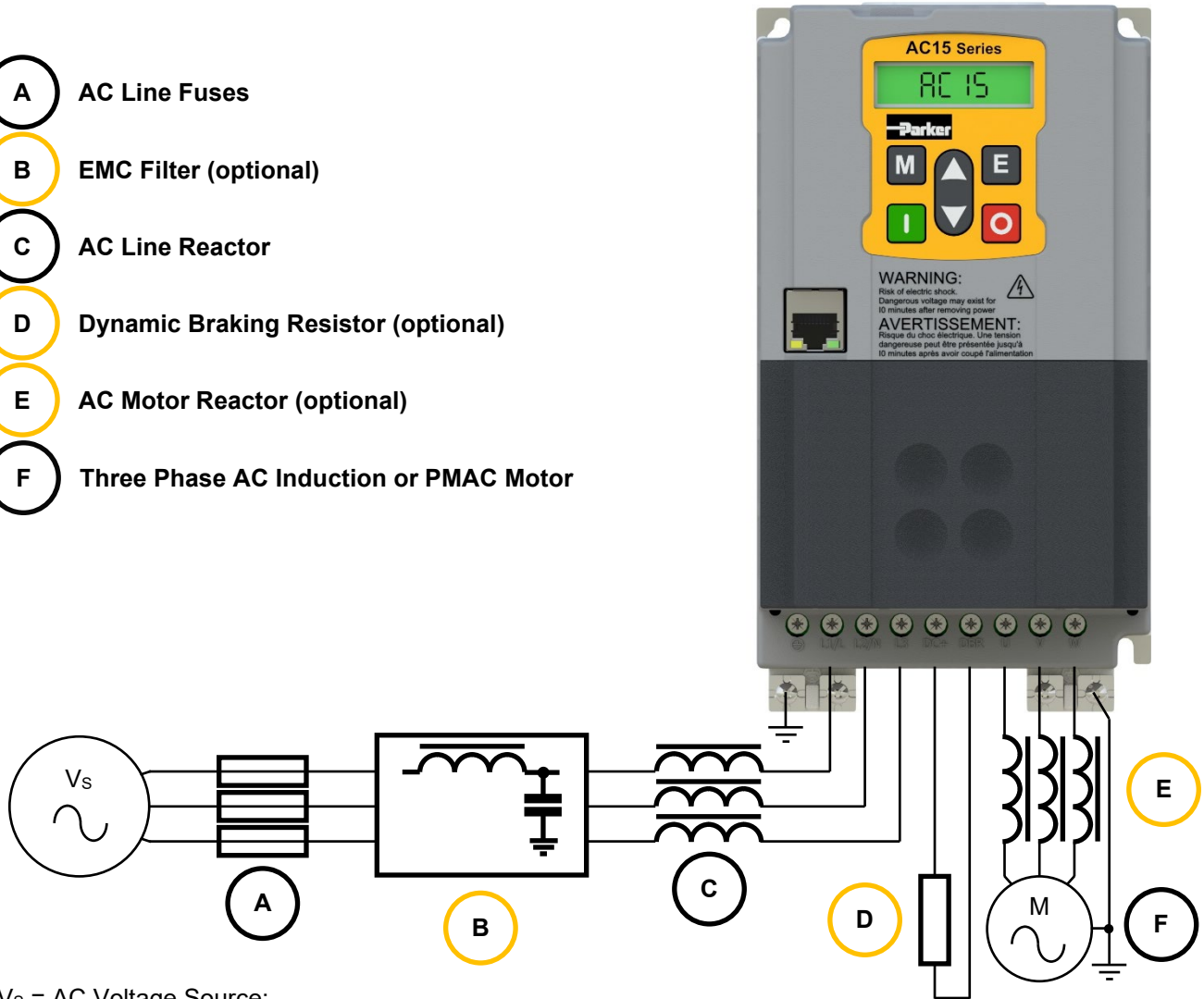

- A** AC Line Fuses
- B** EMC Filter (optional)
- C** AC Line Reactor
- D** Dynamic Braking Resistor (optional)
- E** AC Motor Reactor (optional)
- F** Three Phase AC Induction or PMAC Motor



V_s = AC Voltage Source:

- 1 \emptyset , 220-240V
- 3 \emptyset , 220-240V
- 3 \emptyset , 380-480V

Key:

-  Mandatory Component
-  Optional Component

7.1 AC Line Fuses

For North America, the recommended fuses are either Mersen A60Q series, 600Vac/dc semiconductor protection fuses or Mersen A50QS series, 500Vac/dc semiconductor protection fuses.

These fuse series are:

1. UL recognised components.
2. When used with these fuses, the AC20 is capable of short circuit rating of 50KA RMS symmetrical amps

7.1.1 1 ϕ , 230V Products

AC15 HP	Frame size	Catalog number	Parker part number	Mersen part number	Fuse Rating amps
0.5	1	15G-11-0025-BF	CS470407U010	A60Q10-2	10
1		15G-11-0045-BF	CS470407U015	A60Q15-2	15
2		15G-11-0070-BF	CS470407U025	A60Q25-2	25
3	2	15G-12-0100-BF	CS470407U025	A60Q25-2	25

7.1.2 3 ϕ , 230V Products

AC15 HP	Frame size	Catalog number	Parker part number	Mersen part number	Fuse Rating amps
0.5	1	15G-31-0025-BF	CS470407U005	A60Q5-2	5
1		15G-31-0045-BF	CS470407U010	A60Q10-2	10
2		15G-31-0070-BF	CS470407U010	A60Q10-2	10
3	2	15G-32-0100-BF	CS470407U020	A60Q20-2	20
5	3	15G-33-0170-BF	CS470407U025	A60Q25-2	25
7.5	4	15G-34-0210-BF	CS470407U030	A60Q30-2	30
10	5	15G-35-0300-BF	CS470408U050	A50QS50-4	50
15		15G-35-0400-BF	CS470408U050	A50QS50-4	50

7.1.3 3 ϕ , 480V Products

AC15 HP	Frame size	Catalog number	Parker part number	Mersen part number	Fuse Rating amps
0.5	1	15G-41-0012-BF	CS470407U005	A60Q5-2	5
1		15G-41-0020-BF	CS470407U005	A60Q5-2	5
2		15G-41-0040-BF	CS470407U005	A60Q5-2	5
3	2	15G-42-0065-BF	CS470407U010	A60Q10-2	10
5		15G-42-0090-BF	CS470407U020	A60Q20-2	20
7.5	3	15G-43-0120-BF	CS470407U020	A60Q20-2	20
10		15G-43-0170-BF	CS470407U030	A60Q30-2	30
15	4	15G-44-0230-BF	CS470407U030	A60Q30-2	30
20		15G-44-0320-BF	CS470407U040	A60Q40-2	40
25	5	15G-45-0380-BF	CS470408U050	A50QS50-4	50
30		15G-45-0440-BF	CS470408U050	A50QS50-4	50
40		15G-45-0600-BF	CS470408U080	A50QS80-4	80

7.2 External EMC Filters

Additional external EMC filters are sometimes required to meet specific conducted emissions standards and environments.

All products have internal filters that meet the Category C3 limits defined in EN61800-3. Where this performance is not adequate for a customer's application, the Conducted Emissions plots provided in 'Chapter 11: Compliance' allow for the selection or design of an additional external EMC filter to meet customer's needs. EMC advice to consider during the product installation can also be found in this section.

7.3 AC Line Chokes

Parker suggests the following AC Line Choke ratings:

7.3.1 1 ϕ , 230V Products

AC15 HP	Frame size	Catalog number	Line Reactor part number	Line Reactor mH	Line Reactor A
0.5	1	15G-11-0025-BF	CO540100U006	4.6	5.5
1		15G-11-0045-BF	CO540100U012	2	12
2		15G-11-0070-BF	CO540100U019	1.4	19
3	2	15G-12-0100-BF	CO540100U019	1.4	19

7.3.2 3 ϕ , 230V Products

AC15 HP	Frame size	Catalog number	Line Reactor part number	Line Reactor mH	Line Reactor A
0.5	1	15G-31-0025-BF	CO540100U005	5	5
1		15G-31-0045-BF	CO540100U006	5	5.5
2		15G-31-0070-BF	CO540100U010	1.4	10
3	2	15G-32-0100-BF	CO540100U012	1	12
5	3	15G-33-0170-BF	CO540100U019	0.6	19
7.5	4	15G-34-0210-BF	CO540100U025	0.5	25
10	5	15G-35-0300-BF	CO540100U034	0.4	34
15		15G-35-0400-BF	CO540100U048	0.3	48

7.3.3 3 ϕ , 480V Products

AC15 HP	Frame size	Catalog number	Line Reactor part number	Line Reactor mH	Line Reactor A
0.5	1	15G-41-0012-BF	CO540101U002	19.2	1.6
1		15G-41-0020-BF	CO540101U003	10.6	2.3
2		15G-41-0040-BF	CO540101U004	6.2	4.2
3	2	15G-42-0065-BF	CO540101U005	4.7	5
5		15G-42-0090-BF	CO540101U008	2.8	8.2
7.5	3	15G-43-0120-BF	CO540101U011	1.9	11
10		15G-43-0170-BF	CO540101U014	1.5	14
15	4	15G-44-0230-BF	CO540101U030	1.1	30
20		15G-44-0320-BF	CO540101U030	1.1	30
25	5	15G-45-0380-BF	CO540101U030	1.1	30
30		15G-45-0440-BF	CO540101U045	0.5	45
40		15G-45-0600-BF	CO540101U055	0.4	55

7.4 Dynamic Braking Kits

The braking kits in the following tables are for occasional stopping duty only. Consult factory for applications requiring continuous braking.

7.4.1 1 ϕ , 230V Products

AC15 HP	Frame size	Catalog number	Braking kit	Min ohms	Braking kit ohms	Braking kit Watts
0.5	1	15G-11-0025-BF	LA471356	80	100	100
1		15G-11-0045-BF	LA471356	80	100	100
2		15G-11-0070-BF	LA471356	80	100	100
3	2	15G-12-0100-BF	LA471356	80	100	100

7.4.2 3 ϕ , 230V Products

AC15 HP	Frame size	Catalog number	Braking kit	Min ohms	Braking kit ohms	Braking kit Watts
0.5	1	15G-31-0025-BF	LA471356	80	100	100
1		15G-31-0045-BF	LA471356	80	100	100
2		15G-31-0070-BF	LA471356	80	100	100
3	2	15G-32-0100-BF	LA471356	80	100	100
5	3	15G-33-0170-BF	LA471359	30	56	500
7.5	4	15G-34-0210-BF	LA471359	30	56	500
10	5	15G-35-0300-BF	LA471362	15	25	756
15		15G-35-0400-BF	LA471362	15	25	756

7.4.3 3 ϕ , 480V Products

AC15 HP	Frame size	Catalog number	Braking kit	Min ohms	Braking kit ohms	Braking kit Watts
0.5	1	15G-41-0012-BF	LA471355	145	200	100
1		15G-41-0020-BF	LA471355	145	200	100
2		15G-41-0040-BF	LA471355	95	200	100
3	2	15G-42-0065-BF	LA471357	90	100	200
5		15G-42-0090-BF	LA471357	90	100	200
7.5	3	15G-43-0120-BF	LA471357	90	100	200
10		15G-43-0170-BF	LA471357	90	100	200
15	4	15G-44-0230-BF	LA471359	50	56	500
20		15G-44-0320-BF	LA471361	30	30	750
25	5	15G-45-0380-BF	LA471361	30	30	750
30		15G-45-0440-BF	LA471361	30	30	750
40		15G-45-0600-BF	LA471362	25	25	756

7.5 Motor Reactor

Consult factory when the motor lead length is expected to exceed 25m for frames 1-3 and 50m for larger frames.

8 Safe Torque Off (STO): SIL2, PLd

8.1 Overview

8.1.1 Introduction

The AC15 is an adjustable speed electrical power drive system that is suitable for safety related applications (PDS(SR)).

The drive is used in typical applications such as pump controls, packaging machines, textile machines, printing machines, or material forming machines.

Safe Torque Off (STO) is an important and widely used safety function, deployed to prevent the unexpected start-up of motors.

STO functionality enables an operator to disable the torque at motor shafts or deactivate forces at linear motors and actuators via digital inputs, before commencing work in a potentially hazardous area.

Application block diagram

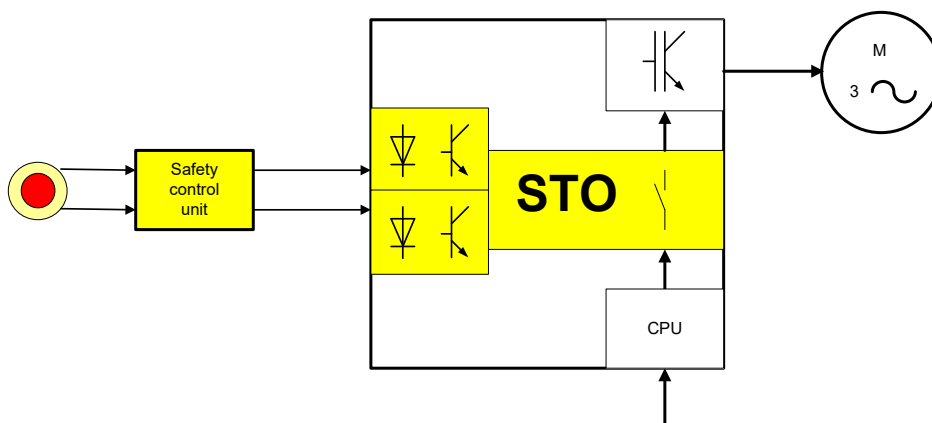

This section provides general information about Safe Torque Off (STO).

Two safety functions can be implemented with the drive:

1. Safe Torque Off (STO)
2. Safe Stop 1 (SS1).

In order to meet all aspects of STO and SS1, an external safety control unit should be used.

To implement Safe Stop 1 (SS1), the external safety control unit causes the drive to decelerate to rest. Once at rest, it invokes STO in the drive. Please refer to EN61800-5-2:2017 para 4.2.3.3 for the formal definitions.

It is the user's responsibility to:

1. Risk assess the machine.
2. Design, implement and assess an appropriate solution for each application to meet all relevant safety requirements.

In accordance with the machine standards 2006/42/EG, EN ISO 12100, EN ISO 13849-1 and EN ISO 14121-1, it is the machine manufacturer who must project the safety system for the entire machine, including all integrated components. This includes the electrical drives.

Note: STO is an electronic inhibit intended for use during normal operation of the machine, but It can also be used in automatic, set-up and cleaning operation modes. However, it is not intended for use during machine maintenance, repair, replacement or other similar activities. For these activities, recognised electrical power isolation devices and lock-off procedures should be used.

The drive STO function is a factory-fitted and factory-tested feature. See 'Section 8.5: STO Safety Warnings and Limitations'.

8.1.2 STO Functional Description

STO is a means of preventing an drive from delivering rotational force to its connected electric motor. Please refer to EN61800-5-2:2017 para 4.2.3.2 for the formal definition.

To ensure a high degree of safety, two independent STO control channels are implemented in hardware, providing the safety sub function STO. The STO circuits in the drive are designed such that a fault in one control channel will not affect the other channel's ability to prevent the drive from starting, i.e., the STO function of the drive is tolerant to any single fault. It may not be tolerant to an accumulation of faults. This is in keeping with its declared safety ratings. For complete STO functionality, it is necessary to use the motor with the correct motor cable and correct STO input wiring.

STO always overrides any attempt to start the drive. If one or both STO control inputs is requesting the STO function, the drive will not start, even if for example, the drive's software malfunctions and tries to cause the motor to turn.

The STO function is implemented in hardware; it overrides all software activities. The only software involvement is to report the STO status to the user via the onboard drive display or remote keypad (MMI), serial communications link, or user terminal as defined by the drive configuration.

8.2 Alignment to European Standards

8.2.1 EN ISO13849-1:2015 (Safety of machinery – Safety-related parts of control systems)

STO aligns internally to the following aspects of this standard:

1. Architecture According to Category 3:

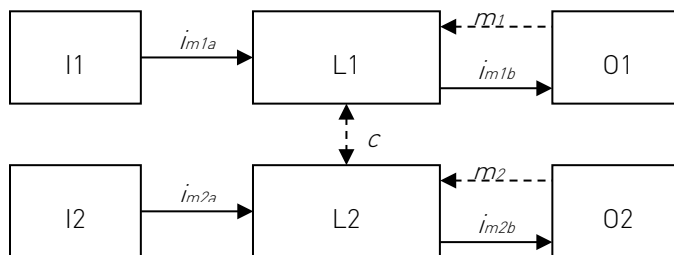

Where:

$I1, I2$ = User Terminal

$L1, L2$ = Logic

$O1, O2$ = Methods of Enabling/Disabling Output Power

im_{xy} = Interconnecting Means

m_x = Monitoring

c = Cross Monitoring

—▶ = STO Control Paths

- - - -▶ = Reasonably Practicable Fault Detection

2. General Requirements of Category 3:

- A single failure will not lead to loss of the STO safety function.
- Failure of more than one component can lead to the loss of the STO safety function.
- Most but not all single component failures will be detected. Diagnostic Coverage (DC) is required to be at least 60% (i.e., the minimum required for 'low' diagnostic coverage).
- Detected component failures will result in the STO function being applied without intervention from the user.
- The risk associated with the loss of STO safety function caused by multiple failures must be understood and accepted by the user.
- The user must undertake a risk analysis and specify suitable components that, when connected together, meet the risk assessment requirements.
- Mean Time To Failure (dangerous) (MTTFd) of each STO channel must be ≥ 30 years.
- Common Cause Failure (CCF) score must be ≥ 65 according to Annex F of the standard.

3. Performance Level (PL) d:

- Average probability of dangerous failure per hour (PFH) must be $\leq 10^{-6}$

8.2.2 EN61800-5-2:2017 (Adjustable speed electrical power drive systems) & EN61508:2010 (Functional safety of electrical/electronic/programmable electronic safety-related systems)

STO aligns to the following aspects of this standard:

Safety Integrity Level (SIL) 2:

- Probability of dangerous random hardware failures per hour (PFH) must be $\leq 10^{-6}$
- Subsystems type A according to EN61508-2:2010 para 7.4.4.1.2.

8.3 Specification

8.3.1 Safety

As assessed to EN ISO13849-1:2015 and EN61800-5-2:2017, the drive has the following related safety values:

PL (STO):	d
SIL (STO):	2
PFH (STO):	4.6×10^{-10} 1/h †
Mission Time:	Maximum 20 years
Fault Detection Time: (Time delay from unequal input logic levels to activation of STO)	Maximum 5sec During input inequality, the motor torque is disabled by the single channel within 15 msec.
STO Response Time: (Time from STO user input initiating removal of energy to the motor)	Maximum 15msec
STO Input Pulse Time: (Active low OSSD from external safety control unit)	Maximum 1.5msec
STO Failure:	If an STO 'Trip 31' code cannot be acknowledged, then defects could be present in the product or in the external STO wiring. Any reported STO fault will require system analysis to establish the cause. Damaged units will need to be exchanged.



† = Note that in assessment of the danger point, the total failure rate is determined by the sum of the failure of all parts

8.3.2 EMC

In addition to the mandatory requirements of EN61800-3, the STO functionality has been subjected to testing for immunity at higher levels. In particular, the STO function (only) has been tested for radiated immunity according to EN61800-5-2:2017 Annex E up to 6GHz which includes frequencies used by mobile transmitters in general.

8.4 STO Operation

8.4.1 Terminal Identifications

Frame 1	Frames 2 – 5
	

Frame 1 Terminal No.	Terminal Ident	Description
13	STOA	STO Input Channel A: <ul style="list-style-type: none"> - 0V or not connected, STO is 'Active' on channel A. Drive will not run. - 24V, STO is 'Disabled' on channel A. Drive will run, providing 24V is present on STO input channel B too. - Input is optically isolated from all other drive terminals except STOB.
14	0V	STO 0V Reference: <ul style="list-style-type: none"> - Signal return for STO input channel A and STO input channel B. - This terminal must be connected to earth at one common point in the drive system.
15	STOB	STO Input Channel B: <ul style="list-style-type: none"> - 0V or not connected, STO is 'Active' on channel B. Drive will not run. - 24V, STO is 'Disabled' on channel B. Drive will run, providing 24V is present on STO input channel A too. - Input is optically isolated from all other drive terminals except STOA.

8.4.2 Input State Truth Table

STO Input Channel A	STO Input Channel B	STO Status	Description
0V	0V	STO ACTIVE	Drive cannot start or supply power to the connected motor. STO trip reported by the drive.
24V	0V	STO ACTIVE (Abnormal one-channel operation detection)	Drive cannot start or supply power to the connected motor. STO trip reported by the drive. If either of these conditions persists for more than 1sec, the STO function can lock into a Fault state.
0V	24V		If either of these conditions persists for more than 5sec, the STO function will lock into a Fault state. Once in the Fault state, the drive cannot start until it has been power cycled (both mains power and any auxiliary 24V supply).
24V	24V	STO INACTIVE	Drive is enabled to run and supply power to the connected motor under software control.
X	X	DRIVE UNPOWERED	Drive cannot start or supply power to the connected motor.

8.4.3 Example Applications

WARNING!

Diagrams are for illustration only:



The wiring examples shown in this section are for illustration only. They are not to be considered as 'final' designs, nor as an attempt to create a design for specific solutions. The user / installer is responsible for designing a suitable system to meet all requirements of the application including assessing and validating it. Parker will not accept any liability for failure to do this or any consequential loss or damage.



Applications NOT Requiring STO Functionality:

The example below shows the drives' 24V output voltage used to permanently wire the STO inputs in the 'High' state, i.e., STO **DISABLED** (drive operational):

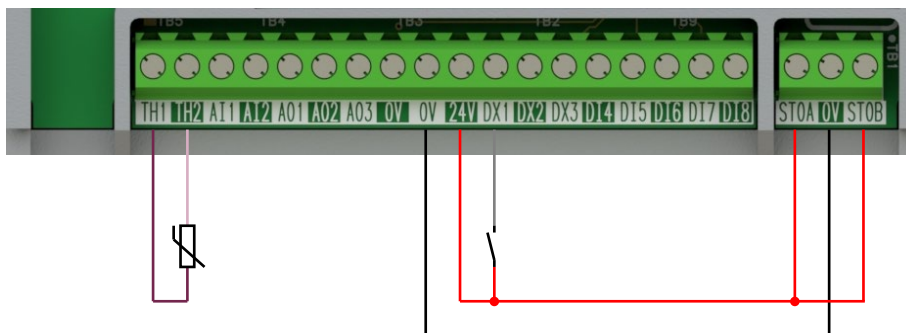

Configuration Setup:	
TH1	Motor Thermistor '+' connection
TH2	Motor Thermistor '-' connection
DX1	Run Forward: 24V digital input
STOA	24V input connected i.e., STO DISABLED (drive operational)
STOB	24V input connected i.e., STO DISABLED (drive operational)

Minimum STO Implementation:

This example shows 'STO Request' contacts that are used to invoke STO on the drive. These contacts are required to close prior to running the drive:

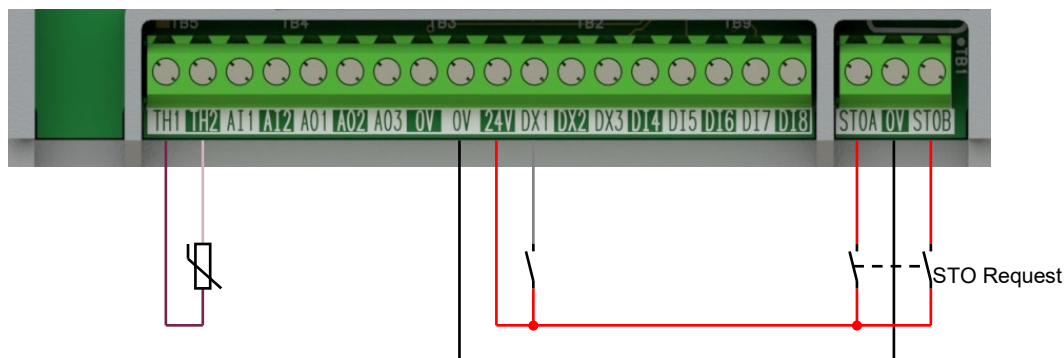

Configuration Setup:	
TH1	Motor Thermistor '+' connection
TH2	Motor Thermistor '-' connection
DX1	Run Forward: 24V digital input
STOA	24V input connected via ' STO Request ' contacts
STOB	24V input connected via ' STO Request ' contacts

To run the drive:

1. Close the 'STO Request' contacts.
2. Close the 'Run Forward' contact.

To stop the drive:

1. Open the 'Run Forward' contact and wait for the motor to come to a standstill.

To invoke STO:

1. When the motor is at standstill, open the 'STO Request' contacts.
2. STO will now be 'Active' on the drive, for as long as required.

Note: Opening the 'STO Request' contacts when the motor is running will result in the motor coasting to a stop.

STO Implementation with a Door Switch (Stop Category 0):

This example shows a safety door switch that is used to invoke STO on the drive when the safety door is 'opened', allowing access into the 'Danger Zone'.

The safety door must return to the 'closed' position prior to running the drive:

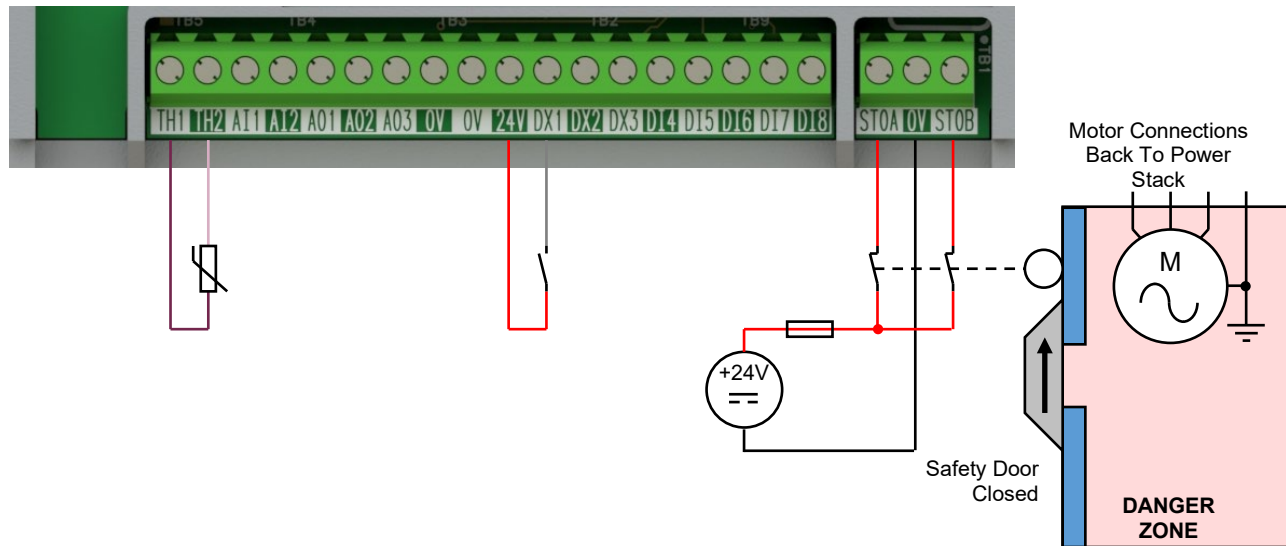

Configuration Setup:

TH1	Motor Thermistor '+' connection
TH2	Motor Thermistor '-' connection
DX1	Run Forward: 24V digital input
STOA	Externally fused 24V input connected via ' Safety Door Closed ' contacts
STOB	Externally fused 24V input connected via ' Safety Door Closed ' contacts

To run the drive:

1. Close the 'Safety Door' so the contacts and closed circuit (STOA & STOB inputs are supplied with 24V).
2. Close the 'Run Forward' contact.

To stop the drive:

1. Open the 'Run Forward' contact and wait for the motor to come to a standstill.

To invoke STO:

1. When the motor is at standstill, open the 'Safety Door' so that the contacts are open circuit (no volts on STOA & STOB inputs).
2. STO will now be 'Active' on the drive, for as long as required.

Note: Opening the 'Safety Door' so that the contacts open when the motor is running will result in the motor coasting to a stop.

The line guiding to the external switches must be separated channel-wise or they must be specially protected i.e., using shielded cables. A relocation of this wiring is not permitted.

In the example illustrated above, the contacts of the 'Safety Door' need to be designed mechanically linked, in accordance with EN 60947-5-1, annex K.

SS1 / STO Implementation using a Safety Control Unit (Stop Category 1):

The example below shows Safe Stop (SS1) implementation that brings a motor to rest in a controlled manner, before invoking STO on the drive after a time delay determined by an external Safety Control Unit.

The Safety Control Unit shown in this example is a Sick UE410-MU module. This configuration conforms to SS1 as defined in EN 61800-5-2:2017 para 4.2.3.3 c). Other products are available on the market that may better suit user's application, so the user must select and assess appropriate equipment:

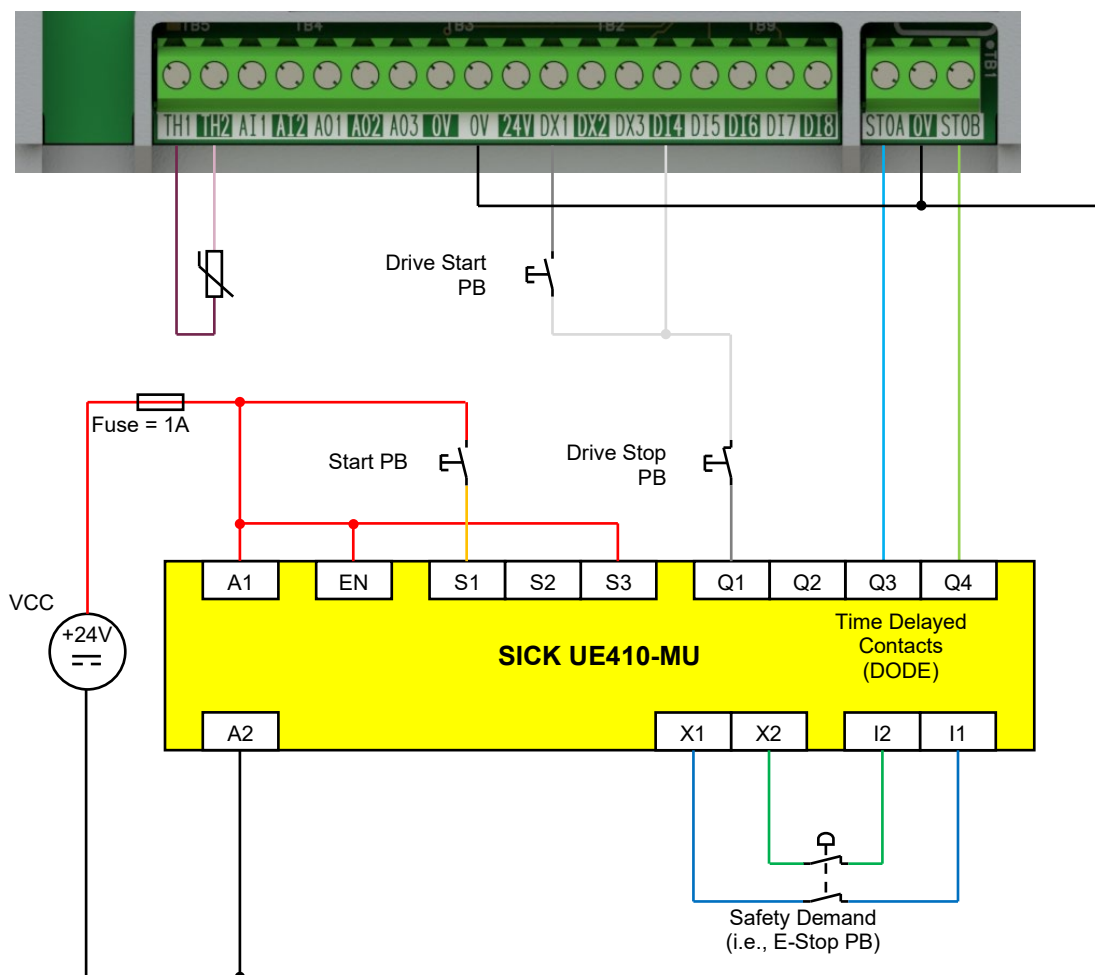

Configuration Setup:	
TH1	Motor Thermistor '+' connection
TH2	Motor Thermistor '-' connection
DX1	Run Forward: 24V digital input
DI4	Stop: 24V digital input
STOA	24V input connected via 'Safety Control Unit' DODE o/p signal
STOB	24V input connected via 'Safety Control Unit' DODE o/p signal

Note: The maximum input level of STOA & STOB inputs is 25.2V. This must be taken into consideration when selecting a 24V power supply to generate VCC, i.e. VCC(max) < 25.2V.

On system power-up:

1. The Safety Control Unit outputs are de-energized (open-circuit), so STO on the drive is invoked (active).

To run the drive:

1. Ensure that the 'Safety Demand' is reset, i.e., contacts are closed.

2. Close the 'Start PB' switch to ensure the Safety Control Unit is reset. This should enable outputs Q3 & Q4, applying 24V onto STOA & STOB inputs, and hence disabling the STO function.
3. Close the 'Drive Start PB' switch to run the drive.

To stop the drive:

1. Open the 'Drive Stop PB' switch and wait for the motor to come to a standstill.

To invoke STO:

1. Open the 'Safety Demand' contacts.
2. If the motor is running, the Safety Control Unit output Q1 will initiate a drive 'Stop' to decelerate the motor to a standstill.
3. Safety Control Unit outputs Q3 & Q4 are configurable DODE (Delay on de-energise) signals that will de-energise on initiation, after a delay time.

The delay time must be setup on the Safety Control Unit device so that the maximum deceleration time of the drive has ensured the motor is at a standstill before the delay time has elapsed.

Note: Opening the 'STO Demand' contacts when the motor is running with an insufficient delay time set, will result in the motor coasting to a stop.

4. Once the time delay has elapsed on Safety Control Unit outputs Q3 & Q4, the outputs will de-energise, and hence STO will now be 'Active' on the drive for as long as required.

Timing diagram (Typical Operation):

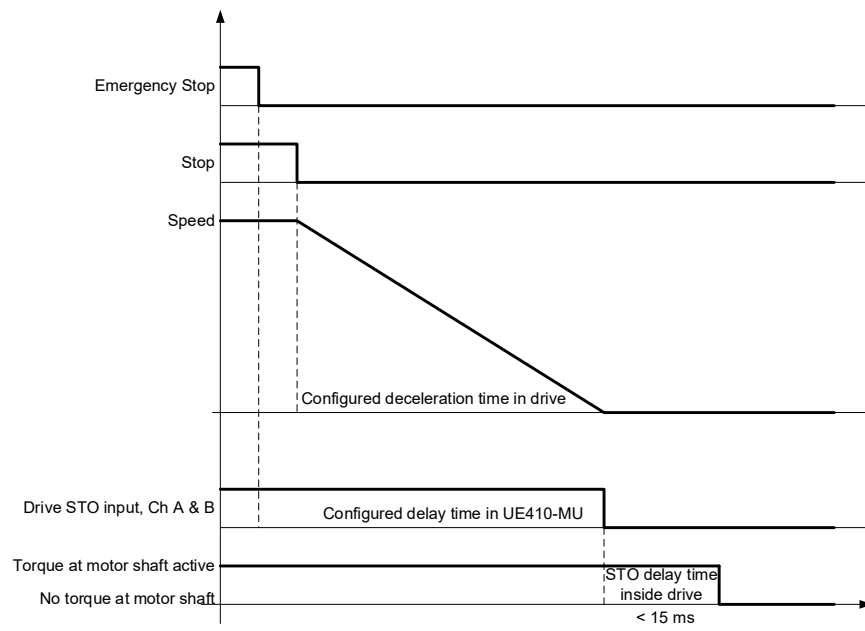

Note: The Q1 output signal from the Safety Control Unit works using test pulses. Therefore, the digital input signal received by the drive must filtered. This can be implemented by adding a 'Debouncing' Function block to the relevant input signal using the DSELite configuration tool.

In the example illustrated, the contacts of the 'Safety Demand' (i.e., Emergency Stop button) need to be designed mechanically linked, in accordance with EN 60947-5-1, annex K.

Other Safety Control Units can be used if it meets all requirements for cat 3 and PLd that have a high-quality fault detection method with dynamic cross monitoring test pulses. The maximum test pulse time of these devices must be < 1.5msec (active low OSSD).

For the delayed initiation of STO, the machinery risks have to be considered from the machine designer.

8.4.4 Technical Specification

Terminal Idents:	STOA, STOB, referenced to 0V
Nominal Input Voltage:	24V PELV (with energy source class 3, according to IEC 62368-1)
Maximum Input Voltage:	25.2V (26.4V in a maximum operating ambient of 40°C)
Recommended Input Voltage for Logic Low Level:	0V – 5V (or open circuit)
Recommended Input Voltage for Logic High Level:	15V – 24V
Indetermined Input Range:	5V – 15V, function is undefined
Typical Input Current:	9mA @ 24V
STO Input Operability:	Always Active (i.e., STO cannot be disabled by the drive firmware)
STO User Input A Logic Level:	0V or open circuit = STO Activated 24V = STO Disabled
STO User Input B Logic Level:	0V or open circuit = STO Activated 24V = STO Disabled
Isolation:	Channel A & B to SELV: Galvanic Isolation. Channel A to Channel B: Non-isolated

8.5 STO Safety Warnings & Limitations

WARNING!



Ignoring the following may result in serious injury or death:

- Only competent personnel are permitted to install the STO function and commission it. They must disseminate and make available all appropriate instructions and documentation to all personnel who may come into contact with or operate the STO and provide suitable training on the drive to ensure it is operated in the correct manner and to avoid damage, injury or loss of life.
Personnel with many years of experience in the field of machine safety with drive is expected.
Planning, installation and initial system commissioning requires a detailed understanding in this area.
- Standards and accident prevention regulation associated with the application must be known and respected as well as risks, protective and emergency measures.
- We assume that these specialists have a good knowledge of English. In the case of deviating regulations (in particular work by persons who do not speak English), the machine manufacturer must provide these persons with the necessary information in the national language.



- It is not permitted to open the drive for repair or modification. The drive STO function is a factory-fitted and factory-tested feature. Repairs to the drive STO featured-product are to be carried out only by Parker authorised repair centres. Any unauthorised attempt to repair or disassemble the product will render any warranty null and void, and STO integrity could be impaired.

PARKER WILL NOT ACCEPT ANY LIABILITY FOR FAILURE TO OBEY THESE INSTRUCTIONS OR FOR ANY CONSEQUENTIAL INJURY, DEATH, LOSS OR DAMAGE.

Only competent personal with relevant experience are allowed to open the drive for making changes to the power filters (i.e. removal of Y-Caps & VDR earth connections), or fitting optional communication cards.

If internal connections between the power stack and control card have been disconnected and reconnected, then the accurate connection must be checked by starting the motor (running the drive), and by performing a STO comprehensive check as specified in Section 8.6.1 below.

- It is important that the drive product environment including all aspects of its CE conformance and IP etc., specified elsewhere in this manual, is maintained to ensure the safety integrity of the STO function.
- Should synchronous motors be operated in the field weakening range, operation of the STO function may lead to overspeed and destructive overvoltages as well as explosions in the drive. Therefore, the STO function must NEVER be used with synchronous drives in the field-weakening range. The user must ensure this condition is prevented.
- When using synchronous permanent magnet motors, shaft movement over a small angle is possible if two faults occur simultaneously in the power section of the drive. This depends on the number of motor poles. The maximum angle is:
 - Rotary motors: $360^\circ / \text{number of poles}$.
 - Linear motors: 180° electrically

It is the user's responsibility to assess, validate and safeguard as necessary against this potential hazard.

- If external forces can act on the motor and/or load to cause it to move, additional measures must be taken by the user to restrain it, for example a mechanical brake. Examples of external forces are suspended loads (effect of gravity), and other web-tensioning devices. This must be respected above all for vertical axes without self-locking mechanical devices or weight balance.
- The drive STO feature does not provide or guarantee any galvanic isolation in accordance with EN 60204-1 Section 5.5. This means that the entire system must be isolated from the mains power supply with a suitable electrical isolation device before any drive or motor maintenance or replacement procedures are attempted. Note that even after the power has been isolated, dangerous electrical voltages may still be present in the drive. Safe discharge times and details are specified in 'Chapter 1: Safety' section of this manual.

- The STO function must not be used for electrical isolation of the drive and power. Whenever any personnel require to work on the drive, associated motor or other power items, they must always use recognised and suitable electrical isolation devices.
- The STO0V terminal must be connected to earth at one common point in the drive system. For multi-drive systems this can be a shared earth point.
- The STO serial communications or display messages relating to accessing or viewing any safety monitoring statuses are for information only and should not be relied on. They are not part of the drive module safety system and its associated PL/SIL declared ratings. Any customer use of these must be appropriately risk assessed in accordance with the relevant standards or regulations.
- The STO safety function must be tested regularly - at least once a week (see Section 8.6.3 below). The comprehensive test must be completed once a year (see section 8.6.1 below).
- When using an external safety control unit with adjustable time delay, for example when implementing an SS1 function, the time delay must be protected to prevent unauthorised adjustment. The adjustable time delay on the safety control unit must be set to a value greater than the duration of the braking ramp controlled by the drive with maximum load inertia and from maximum speed. Any external forces must also be considered, e.g. effects due to gravity.
- During the active braking phase of SS1 or Stop category 1 (controlled stop with safely monitored time delay according to EN60204-1), faulty operation of the drive must be allowed for. If a fault in the drive system occurs during the active braking phase, the load may coast to an unguided stop or might even actively accelerate until expiration of the defined time delay. It is not the remit of this document to specify these measures. This is for the user to assess.
- It is the user's responsibility to ensure that their overall control implementation recovers safely from supply loss or dips.
- In all instances it is the user's responsibility to formally perform suitable risk assessments and invoke and fully validate the necessary risk reduction measures after having thoroughly understood the application, the drive product, and its features. Of special relevance is to assess the risk of the two STO user inputs shorting together.
- There is maximum cable length of 25m for the STO inputs allowed.

8.6 STO Functional Checks

Two levels of STO functional checks are required periodically:

- Comprehensive check
- Regular check

The user / machine builder must determine the frequency of these checks based on their knowledge, use of the machine, appropriate standards and any legal requirements.

When STO becomes active during any test, power to the motor must be seen by the user to be quenched instantaneously (the drive should respond in less than 15 milliseconds).

All STO checks should be performed after the drive has been commissioned for speed control.

8.6.1 Comprehensive Checks

A comprehensive check of the STO function ensures the overall integrity of the STO functionality. It proves the independent operation of each channel individually (including during the normal dual channel operation), and the essential single fault detection.

It must always be performed:

- During factory test.
- During commissioning activities.
- After repair or replacement of the drive.
- After any hardware or software design changes which may affect the drive concerned.
- After each intervention into the system and control wiring.
- A minimum of once per year.
- If the machine has been idle for more than a period of time determined by the machinery builder and user risk assessments.

The check must be made by suitably qualified professional personnel following all necessary safety precautions. They must be fully conversant with all equipment concerned.

Note: In the following text where it is required that “all power” is removed, remove power and wait 10 minutes.

The performance of the individual test steps of the STO function should be logged.

WARNING!

Potential loss of Safety Function:



During this test, the safety function must not be relied on because at times only one channel will be activated and therefore the intended safety function may not be available.

STO will be activated while the motor is rotating, which is not the normal operation. Therefore, the user must ensure it is safe to do this test using an appropriate risk assessment and taking any additional risk reduction measures.



The following steps must be performed and recorded during a comprehensive check:

STO Test Step	Test Check or Activity	Expected Reaction & Effect
Initial Check (Basic Drive Functionality)		
1	Firstly, ensure that no harm can come to personnel or equipment if the motor turns.	None.
2	Apply +24Vdc to the drive control board terminals STOA and STOB, and 0V to the STO 0V terminal.	None.
3	Switch on power to the drive.	No error must be present in the drive system.
4	Configure the drive and associated equipment if necessary, so that it can be started and stopped, and responds to a speed setpoint provided.	No error must be present in the drive system.
5	Try to start the drive with a non-zero setpoint. This setpoint value will be referred to as SPT1 for brevity in these tests. Leave this set throughout all tests.	Drive must start and the motor must turn at SPT1.

STO Test Step	Test Check or Activity	Expected Reaction & Effect
STO Channel A Check		
6	With the drive running and the motor turning at SPT1, momentarily disconnect terminal STOA (maximum duration of disconnect = 1 second), while retaining +24V at terminal STOB.	Motor must immediately coast to a rest. Drive must report a STO trip immediately.
7	Ensure terminals STOA and STOB are both 24V. Try to restart the drive.	STO trip must clear. Drive must restart at SPT1.
STO Channel B Check		
8	With the drive running and the motor turning at SPT1, momentarily disconnect terminal STOB (maximum duration of disconnect = 1 second), while retaining +24V at terminal STOA.	Motor must immediately coast to a rest. Drive must report a STO trip immediately.
9	Ensure terminals STOA and STOB are both 24V. Try to restart the drive.	STO trip must clear. Drive must restart at SPT1.
STO Channel A Fault Check		
10	Ensure the drive is running and that the motor is turning at SPT1. Disconnect terminal STOA for approximately 5 seconds (must exceed 3 seconds).	Motor must immediately coast to a rest. Drive must report a STO trip immediately.
11	The STO function has latched in hardware to disable the drive. Re-apply 24V to terminal STOA, and then try to restart drive.	STO trip must not clear. Drive must not start.
12	Remove and re-apply all power to the drive	None.
13	Try to restart drive at SPT1.	Drive must start at SPT1.
STO Channel B Fault Check		
14	Ensure the drive is running and that the motor is turning at SPT1. Disconnect terminal STOB for approximately 5 seconds (must exceed 3 seconds).	Motor must immediately coast to a rest. Drive must report a STO trip immediately.
15	The STO function has latched in hardware to disable the drive. Re-apply 24V to terminal STOB, and then try to restart drive.	STO trip must not clear. Drive must not start.
16	Remove and re-apply all power to the drive	None.
17	Try to restart drive at SPT1.	Drive must start at SPT1.
18	Stop the drive.	Drive must decelerate to rest.

Once the relevant safety test steps have been successfully completed, action must be taken to document the result. An example protocol specimen is provided below.

Please note that additional or alternative tests may be required depending on the Machine design.

8.6.2 Test Protocol Specimen

Project /
Machine: _____

Name of Tester: _____

Reference of
Drive: _____

STO
Functionality: Successfully tested (Test steps 1 – 18)

Safe Stop 1: Successfully tested
 Is not used

Date of Initial
Test: _____

Date of
Repeated Test: _____

Signature of
Tester: _____

Signature of
Tester: _____

8.6.3 Regular Checks

A regular check is intended only to demonstrate that the STO is functional. It will not always detect the loss of a single channel, so it is therefore important for the user and/or machinery builder to determine the frequency of the comprehensive checks based on their knowledge and application of the machine.

A regular check is recommended once per week.

Where a regular check coincides with the timing of a comprehensive check, the comprehensive check must take precedence.

The following steps must be performed and recorded during a regular check:

STO Test Step	Test Check or Activity	Expected Reaction & Effect
1	Firstly, ensure that no harm can come to personnel or equipment if the motor turns.	None.
2	Apply +24Vdc to the drive control board terminals STOA and STOB, and 0V to the STO 0V terminal.	None.
3	Switch on power to the drive.	No error must be present in the drive system.
4	Try to start the drive with a non-zero setpoint. This setpoint value will be referred to as SPT1 for brevity in these tests. Leave this set throughout all tests.	Drive must start and the motor must turn at SPT1.
5	With the drive running and the motor turning at SPT1, disconnect terminal STOA and STOB within 1 second of one another. Leave both disconnected for approximately 5 seconds.	Motor must immediately coast to a rest. Drive must report a STO trip immediately.

STO Test Step	Test Check or Activity	Expected Reaction & Effect
6	Reapply +24V to terminals STOA and STOB and acknowledge the STO trip.	STO trip must clear.
7	Try to restart the drive at SPT1.	Drive must restart at SPT1.
8	Stop the drive.	Drive must decelerate to rest.

This test can also be automated - where the STO channels can be triggered via contacts of an external relay.

8.7 STO Troubleshooting







The table below is for guidance only and may not be a comprehensive list of all possible symptoms relating to STO.

Parker will not accept responsibility for any consequences arising from its incompleteness or inaccuracy.

Problem	AC15 Display	STO Input Channel A wrt 0V	STO Input Channel B wrt 0V	Possible Cause	Description
Drive will not run when given a start command	Tripped: 31 Safe Torque Off	< 15.0V	< 15.0V	STO is invoked.	When safe to do so, connect STOA and STOB to a 24Vdc supply.
	Tripped: 31 Safe Torque Off	>15.0V & < 25.2V*	>15.0V & < 25.2V*	STO Fault Latch may have tripped.	Remove all power from the drive before re-applying. If symptom persists, immediately return the drive for repair.
	Tripped: (Any other trip 1-30 or 32-37)	>15.0V & < 25.2V*	>15.0V & < 25.2V*	Drive has tripped, but not due to STO.	Reset the trip and remove its cause. If symptom persists, return the drive for repair.
	Any other message	>15.0V & < 25.2V*	>15.0V & < 25.2V*	Faulty Hardware.	Return the drive for repair.
Drive starts unexpectedly	X	< 5.0V	< 5.0V	Faulty Hardware.	Immediately return the drive for repair.
	X	> 5.0V	> 5.0V	STO not invoked by the user.	Use STO in accordance with the instructions documented in this chapter.
Drive fails Comprehensive or Regular STO test	X	X	X	Faulty Hardware.	Immediately return the drive for repair.

*26.4V in a maximum operating ambient of 40°C

9.1.2 Onboard Drive Keypad & Display Overview



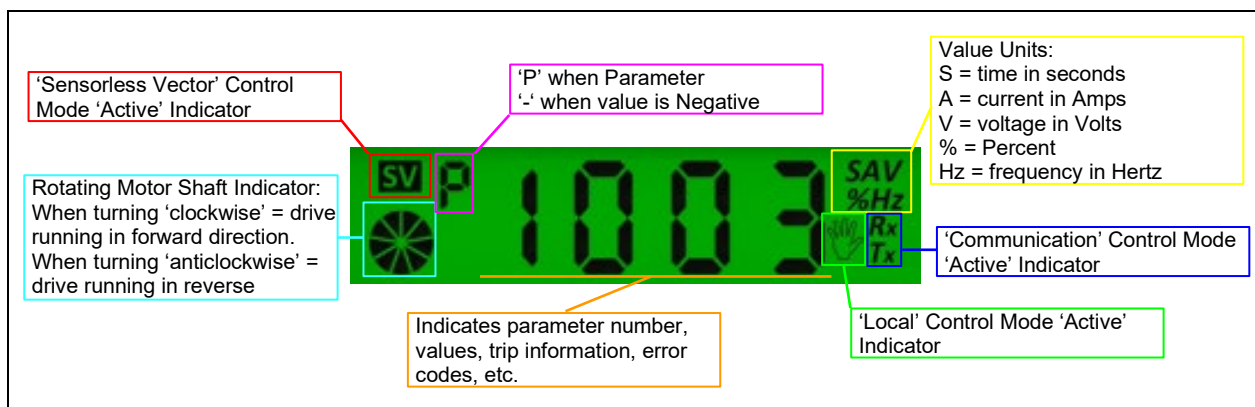



Keypad Overview	
	
Navigation / Parameter Edit Keys	
	<p>MENU Key</p> <p>Navigation - Displays the next Menu level, or the first parameter of the current Menu. Parameter - Allows a writable parameter to be modified.</p>
	<p>UP Key</p> <p>Navigation - Moves upwards through the list of parameters. Parameter - Increments the value of the displayed parameter. Press simultaneously with 'STOP' key to select 'Forward' direction when in 'Local' mode.</p>
	<p>DOWN Key</p> <p>Navigation - Moves downwards through the list of parameters. Parameter - Decrements the value of the displayed parameter. Press simultaneously with 'STOP' key to select 'Reverse' direction when in 'Local' mode.</p>
	<p>ESCAPE Key</p> <p>Navigation - Displays the previous level's Menu. Parameter - Returns to the parameter list. Trip Acknowledge - Acknowledges displayed Trip or Error message.</p>
Local Mode Operating Keys	
	<p>RUN Key</p> <p>Control - Runs the motor at a speed determined by the LOCAL SETPOINT. Trip Reset - Resets any trips and then runs the motor as above. Only operates when the Drive is in 'Local' Start/Stop (Seq) mode.</p>
	<p>STOP / RESET Key</p> <p>Control - Stops the motor. Only operates when the Drive is in 'Local' Sequence mode. Trip Reset - Resets any trips and clears displayed message if trip is no longer active. Press and hold for approx. 3 seconds to toggle between 'Local' & 'Remote' modes of operation. Press simultaneously with 'UP' or 'DOWN' key to change direction when in 'Local' mode.</p>
Display	



9.1.3 6901 Remote Keypad & Display Overview

6901 Keypad Overview

Navigation / Parameter Edit Keys	
	<p>UP Key</p> <p>Navigation - Moves upwards through the list of parameters. Parameter - Increments the value of the displayed parameter.</p>
	<p>DOWN Key</p> <p>Navigation - Moves downwards through the list of parameters. Parameter - Decrements the value of the displayed parameter.</p>
	<p>ESCAPE Key</p> <p>Navigation - Displays the previous level's Menu. Parameter - Returns to the parameter list. Trip Acknowledge - Acknowledges displayed Trip or Error message.</p>
	<p>MENU Key</p> <p>Navigation - Displays the next Menu level, or the first parameter of the current Menu. Parameter - Allows a writable parameter to be modified (this is indicated by → appearing on the left of the bottom line).</p>
	<p>PROGRAM Key</p> <p>No Function.</p>

	<p>LOCAL / REMOTE Mode Select Key Control - Toggles between Remote and Local Control for both Start/Stop (Seq) and Speed Control (Ref). When toggling, the display automatically goes to the relevant SETPOINT screen, and the SETPOINT (LOCAL) screen will have the ▲ and ▼ keys enabled to alter the setpoint.</p>																																								
Local Mode Operating Keys																																									
	<p>RUN Key Control - Runs the motor at a speed determined by the LOCAL SETPOINT. Trip Reset - Resets any trips and then runs the motor as above. Only operates when the Drive is in Local Start/Stop (Seq) mode.</p>																																								
	<p>DIRECTION Key Control - Changes the direction of motor rotation. Only operates when the Drive is in Local Speed Control mode.</p>																																								
	<p>JOG Key Control - Runs the motor at a speed determined by the JOG SETPOINT parameter. When the key is released, the Drive returns to the "STOPPED" state. Only operates when the drive is "STOPPED", and in Local Start/Stop mode.</p>																																								
	<p>STOP / RESET Key Control - Stops the motor. Only operates when the Drive is in Local Sequence mode. Trip Reset - Resets any trips and clears displayed message if trip is no longer active.</p>																																								
Status Indicator LEDs																																									
	<table border="1"> <thead> <tr> <th>'SEQ' LED</th> <th>'REF' LED</th> <th>Drive Status</th> </tr> </thead> <tbody> <tr> <td style="text-align: center;">○</td> <td style="text-align: center;">○</td> <td>Start/Stop (Seq) and Speed Control (Ref) are controlled from the drive terminals.</td> </tr> <tr> <td style="text-align: center;">●</td> <td style="text-align: center;">○</td> <td>Start/Stop (Seq) is controlled using the RUN, STOP, JOG and FWD/REV keys. Speed Control (Ref) is controlled from the drive terminals.</td> </tr> <tr> <td style="text-align: center;">○</td> <td style="text-align: center;">●</td> <td>Start/Stop (Seq) is controlled from the terminals</td> </tr> <tr> <td style="text-align: center;">●</td> <td style="text-align: center;">●</td> <td>Speed Control (Ref) is controlled using the up (▲) and down (▼) keys</td> </tr> </tbody> </table>	'SEQ' LED	'REF' LED	Drive Status	○	○	Start/Stop (Seq) and Speed Control (Ref) are controlled from the drive terminals.	●	○	Start/Stop (Seq) is controlled using the RUN, STOP, JOG and FWD/REV keys. Speed Control (Ref) is controlled from the drive terminals.	○	●	Start/Stop (Seq) is controlled from the terminals	●	●	Speed Control (Ref) is controlled using the up (▲) and down (▼) keys																									
'SEQ' LED	'REF' LED	Drive Status																																							
○	○	Start/Stop (Seq) and Speed Control (Ref) are controlled from the drive terminals.																																							
●	○	Start/Stop (Seq) is controlled using the RUN, STOP, JOG and FWD/REV keys. Speed Control (Ref) is controlled from the drive terminals.																																							
○	●	Start/Stop (Seq) is controlled from the terminals																																							
●	●	Speed Control (Ref) is controlled using the up (▲) and down (▼) keys																																							
	<table border="1"> <thead> <tr> <th>'OK' LED (HEALTH)</th> <th>'I' LED (RUN)</th> <th>'O' LED (STOP)</th> <th>Drive Status</th> </tr> </thead> <tbody> <tr> <td style="text-align: center;">◐</td> <td style="text-align: center;">◐</td> <td style="text-align: center;">◐</td> <td>Drive in CONFIGURATION mode.</td> </tr> <tr> <td style="text-align: center;">◐</td> <td style="text-align: center;">○</td> <td style="text-align: center;">●</td> <td>Drive TRIPPED.</td> </tr> <tr> <td style="text-align: center;">●</td> <td style="text-align: center;">○</td> <td style="text-align: center;">●</td> <td>Drive STOPPED.</td> </tr> <tr> <td style="text-align: center;">●</td> <td style="text-align: center;">○</td> <td style="text-align: center;">◐</td> <td>Drive STOPPING.</td> </tr> <tr> <td style="text-align: center;">●</td> <td style="text-align: center;">◐</td> <td style="text-align: center;">○</td> <td>Drive RUNNING with ZERO SPEED demand or enable false or contactor feedback false.</td> </tr> <tr> <td style="text-align: center;">●</td> <td style="text-align: center;">●</td> <td style="text-align: center;">○</td> <td>Drive RUNNING.</td> </tr> <tr> <td style="text-align: center;">●</td> <td style="text-align: center;">○</td> <td style="text-align: center;">◐</td> <td>Drive performing an AUTOTUNE routine.</td> </tr> <tr> <td style="text-align: center;">◐</td> <td style="text-align: center;">○</td> <td style="text-align: center;">●</td> <td>Drive awaiting AUTO RESTARTING, waiting for TRIP cause to clear.</td> </tr> <tr> <td style="text-align: center;">◐</td> <td style="text-align: center;">○</td> <td style="text-align: center;">○</td> <td>Drive AUTO RESTARTING.</td> </tr> </tbody> </table>	'OK' LED (HEALTH)	'I' LED (RUN)	'O' LED (STOP)	Drive Status	◐	◐	◐	Drive in CONFIGURATION mode.	◐	○	●	Drive TRIPPED.	●	○	●	Drive STOPPED.	●	○	◐	Drive STOPPING.	●	◐	○	Drive RUNNING with ZERO SPEED demand or enable false or contactor feedback false.	●	●	○	Drive RUNNING.	●	○	◐	Drive performing an AUTOTUNE routine.	◐	○	●	Drive awaiting AUTO RESTARTING, waiting for TRIP cause to clear.	◐	○	○	Drive AUTO RESTARTING.
'OK' LED (HEALTH)	'I' LED (RUN)	'O' LED (STOP)	Drive Status																																						
◐	◐	◐	Drive in CONFIGURATION mode.																																						
◐	○	●	Drive TRIPPED.																																						
●	○	●	Drive STOPPED.																																						
●	○	◐	Drive STOPPING.																																						
●	◐	○	Drive RUNNING with ZERO SPEED demand or enable false or contactor feedback false.																																						
●	●	○	Drive RUNNING.																																						
●	○	◐	Drive performing an AUTOTUNE routine.																																						
◐	○	●	Drive awaiting AUTO RESTARTING, waiting for TRIP cause to clear.																																						
◐	○	○	Drive AUTO RESTARTING.																																						

	‘◀’ LED (REV)	‘▶’ LED (FWD)	Drive Status
			Drive RUNNING. Requested direction and actual direction are forward.
			Drive RUNNING. Requested direction and actual direction are reverse.
			Drive RUNNING. Requested direction is forward but actual direction is reverse.
			Drive RUNNING. Requested direction is reverse but actual direction is forward.

9.1.4 Keypad Menu Navigation Examples

Below are some examples of how the keypad keys are used to navigate through the sub-menu lists:

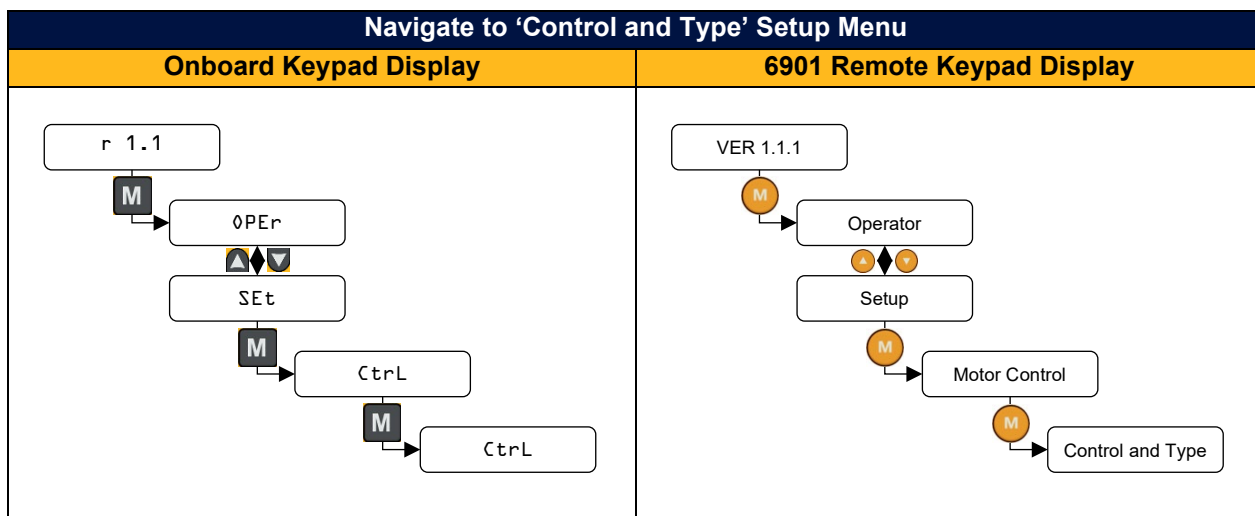
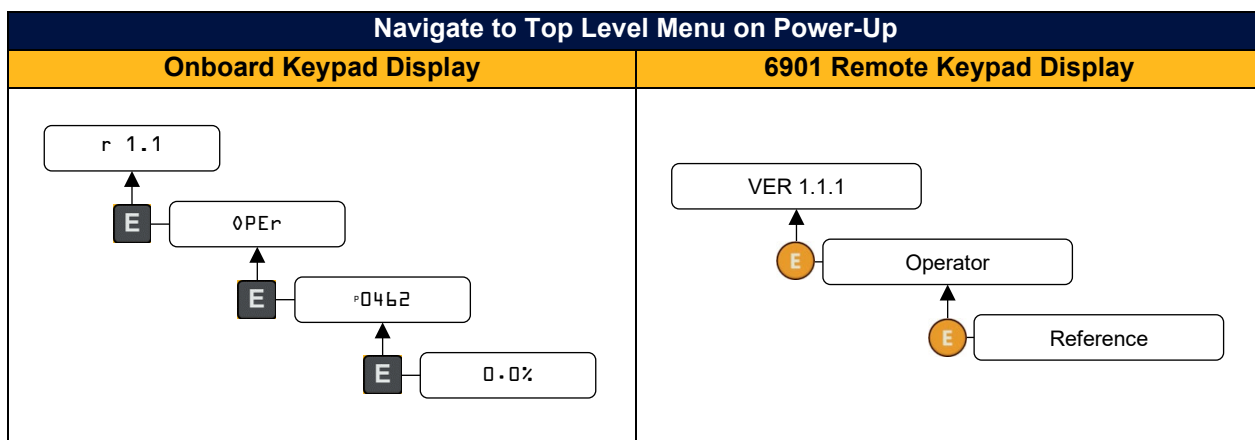

9.1.5 Basic Drive Setup

With the drive now wired, power can be applied.

Once powered up with the drive display illuminated, the following steps need to be completed by navigating through either the onboard or 6901 remote keypad, before running the drive:

1. Initial Drive Setup:

- Control Strategy: set the motor type and control strategy.
 - Motor Nameplate: enter the motor nameplate information.
2. Local Control:
- Enable 'Local' Control Mode - to run the drive from either the onboard or remote keypad.
 - 'Autotune' routine - only required if 'Vector Control' Strategy is selected.
 - Run the drive - set a speed setpoint and issue a drive run command to rotate the motor.
 - Stop the drive - bring the motor back to a standstill.
 - Change the motor direction – to run the motor in reverse.

Note: By default, parameter value changes are saved automatically. Refer to the 'AC15 Series Software Reference Manual' (DOC-0017-05) for details.

Initial Drive Setup

On drive power-up:

- The onboard keypad display will revert to the 'Oper' menu. Press the 'E' key three times to exit to the top menu level, so "r x.x" is shown on the display (where 'x.x' is firmware version).
- If connected, the 6901 remote display will revert to the 'Operator' menu. Press the 'E' key two times to exit to the top menu level, so "VER x.x.x" is shown on the display (where 'x.x.x' is firmware version).

1. Control Strategy Settings:

To setup the drives 'Motor Type' and 'Control Strategy':

- Navigate to the 'Setup' menu:

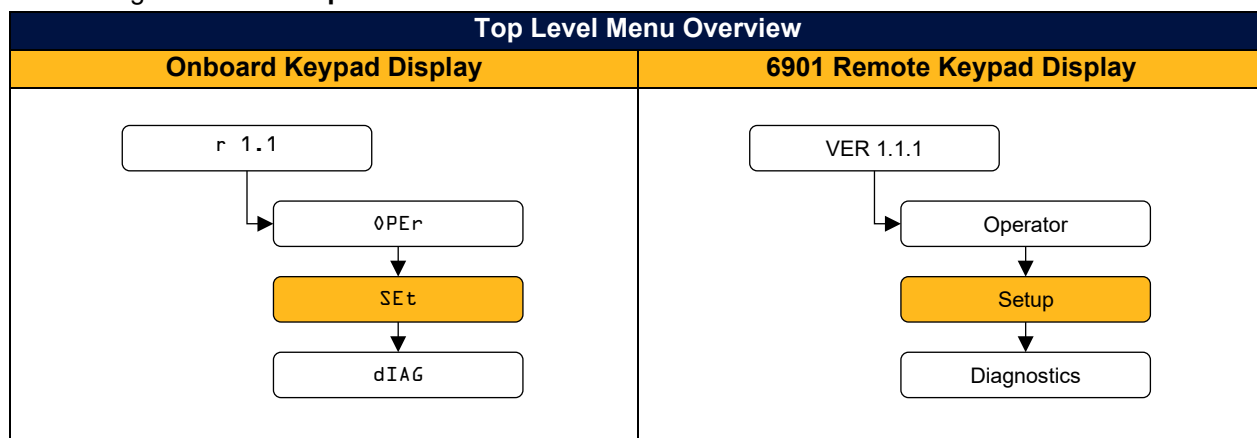

- Navigate to the 'Control and Type' sub-menu:

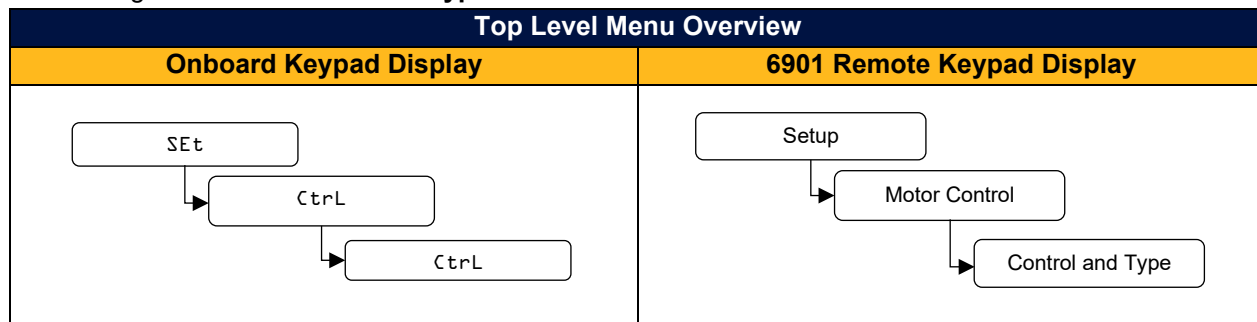

Note: The parameters displayed in this list will vary depending on what settings have been selected i.e., 'Motor Type' & 'Control Strategy' parameters.

- Enter values as required ('key' parameters listed below only):

Parameter Name	No.	Default Value	Range	Units	Type	Writable
Thermistor Type	0892	0: PTC	0: PTC 1: NTC		ENUM	ALWAYS
Motor Type	0030	0: Induction Motor	0: Induction motor 1: PMAC Motor		ENUM	STOPPED
Control Strategy	0031	0: Volts-Hertz Control	0: Volts-Hertz Control 1: Vector Control		ENUM	STOPPED

2. Motor Nameplate Settings:

a) Induction Motor

To enter the 'Motor Nameplate' information for an Induction Motor:

- Navigate to the 'Motor Nameplate' sub-menu:

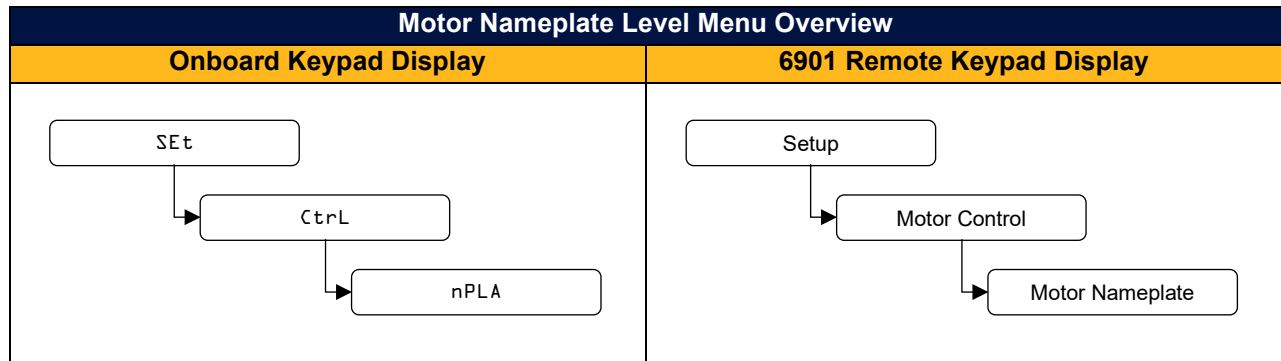

- Enter values as required:

Parameter Name	No.	Default Value	Range	Units	Type	Writable
Base Frequency	0224	50	1 to 1000	Hz	REAL	STOPPED
Base Voltage	0223	400.00	1 to 1000	V	REAL	STOPPED
Nameplate Speed	0226	1450	0 to 100000	rpm	REAL	STOPPED
Motor Power	0227	0.75	0 to 3000	kW	REAL	STOPPED
Power Factor	0228	0.71	0 to 1		REAL	STOPPED
Rated Current	0222	1.56	0.05 to 10000.0	A	REAL	STOPPED
IM Wiring	0182	0: FALSE	0: FALSE 1: TRUE		BOOL	STOPPED

Note: Setting 'IM Wiring' to '1' (TRUE) electronically swaps phases V & W - inverting motor direction.

b) PMAC Motor

To enter the 'Motor Data PMAC' information for a PMAC Motor:

- Navigate to the 'Motor Data PMAC' sub-menu:

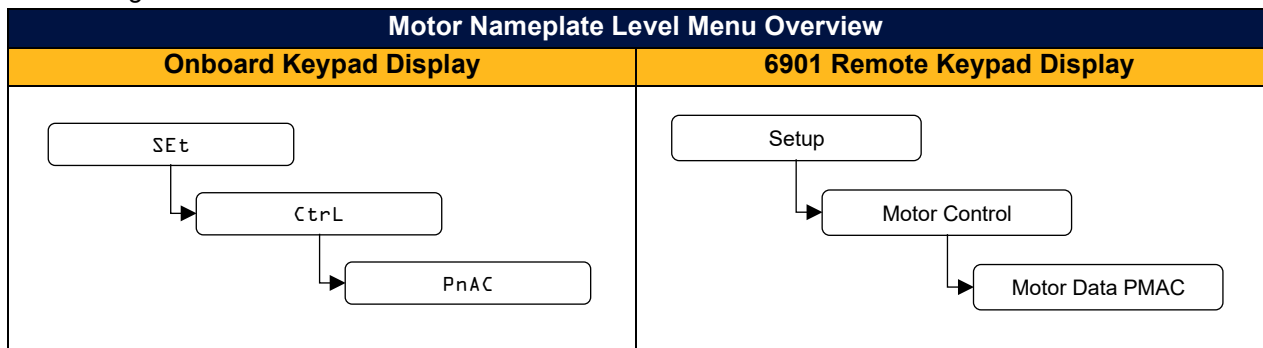

- Enter values as required:

Parameter Name	No.	Default Value	Range	Units	Type	Writable
PMAC Back EMF Ke	0284	60.0	0.1 to 30000.0	V	REAL	ALWAYS
PMAC Base Volt	0290	400.00	1 to 1000	V	REAL	ALWAYS
PMAC Max Speed	0279	3000	1.0 to 100000.0	rpm	REAL	ALWAYS
PMAC Max Current	0280	4.50	0.05 to 5000	A	REAL	ALWAYS
PMAC Mot Inertia	0288	0.0010	0.0010 to 100.0	kgm ²	REAL	ALWAYS
PMAC Motor Poles	0283	10	2 to 400		UINT	ALWAYS
PMAC Rated Cur	0281	4.50	0.05 to 5000	A	REAL	ALWAYS
PMAC Rated Torq	0282	4.50	0.01 to 30000.0	Nm	REAL	ALWAYS



PMAC Therm TC	0289	62	1 to 10000	s	TIME	ALWAYS
PMAC Torque KT	0287	1.00	0.01 to 10000.0	Nm/A	REAL	ALWAYS
PMAC Winding Ind	0286	20.00	0.01 to 1000.0	mH	REAL	ALWAYS
PMAC Winding Res	0285	6.580	0.001 to 500.0	Ohm	REAL	ALWAYS
PMAC Wiring	0291	0: Standard	0: Standard 1: Reverse		ENUM	ALWAYS

Note: Setting 'PMAC Wiring' to 'Reverse' electronically swaps phases V & W - inverting motor direction.



'Local' Operation

1. Enable 'Local' Control Mode:

To enable 'Local' Control Mode:

Local Control Mode Selection	
Onboard Keypad Display	6901 Remote Keypad Display
 <p>Press and hold the 'Stop' key for approx. 3 seconds as "L ... O ... C" appears across the display.</p>	 <p>Press the 'L/R' key.</p>

Once 'Local' Control Mode is enabled, the drive will show the following status indication:

Local Control Mode 'Enabled'	
Onboard Keypad Display	6901 Remote Keypad Display
 <p>A hand icon will appear on the display.</p>	 <p>The 'SEQ' & 'REF' LEDs will illuminate.</p>

2. 'Autotune' Routine ('Vector Control' Strategy Only):

If parameter **0031 (Control Strategy)**, has been set to '1' (**Vector Control**), an 'Autotune' routine will need to be performed prior to running the drive. This is required for the drive to calculate and model the motor parameters (i.e., Magnetising Current, Rotor Time Constant, Stator Resistance, Mutual & Leakage Inductances), for better speed and torque control. Failure to perform an 'Autotune' routine will result in poor motor control, or most likely spurious drive trips when enabled.

There are two types of 'Autotune' routine:

1. Rotating
2. Stationary

A '**Rotating**' autotune on an uncoupled motor is always the preferred autotune 'Type' whenever possible. If this is not practical, a '**Stationary**' routine is possible where the motor shaft will not rotate. However, the result is usually lower dynamic performance.

To perform an 'Autotune' routine:

- Navigate to the '**Autotune**' sub-menu:

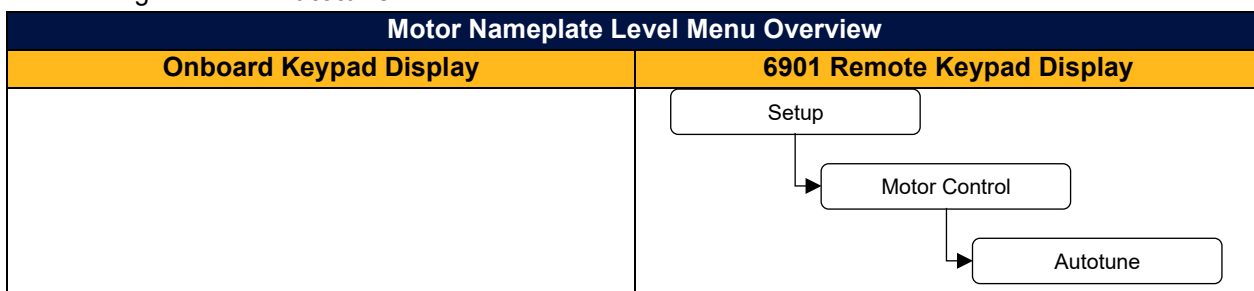

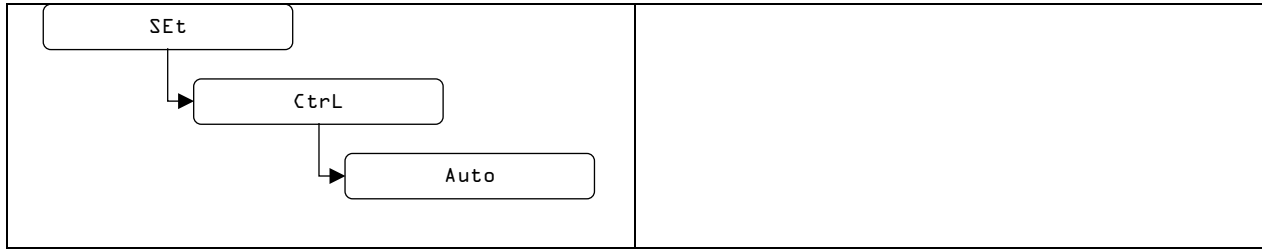

- Parameter **0036 (Atn Mode)** is set to '1' (**Rotating**) by default (recommended), but if this is not possible, change it to '0' (**Stationary**).
- Next, set parameter **0035 (Atn Enable)** to '1' (**TRUE**).

Parameter Name	No.	Default Value	Range	Units	Type	Writable
Atn Mode	0036	1: Rotating	0: Stationary 1: Rotating		ENUM	STOPPED
Atn Enable	0035	0: FALSE	0: FALSE 1: TRUE		BOOL	STOPPED

To start the 'Autotune' routine:

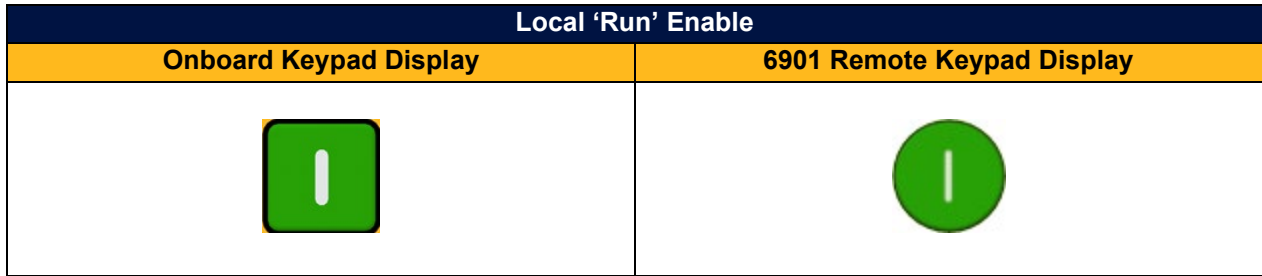

- Press the 'Run' key:

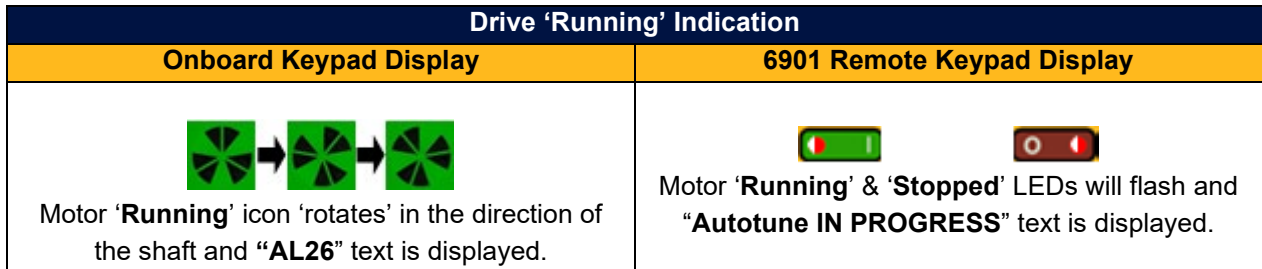

- The drive should run through a pre-determined routine.
- When the 'Autotune' routine is running, the drive will show the following status indication:



- At the end of the 'Autotune' routine, the motor will decelerate to a stop and the drive will disable:

Drive 'Stopped' Indication	
Onboard Keypad Display	6901 Remote Keypad Display
 <p>Motor 'Running' icon will continue 'rotating' during motor deceleration, until the motor has come to a stop.</p>	 <p>When the motor has come to a stop, the 'Running' LED will turn off, and the 'Stopped' LED will illuminate.</p>

- The drive is now ready to run in 'Vector Control' mode.

3. Running The Drive:

To run the drive:

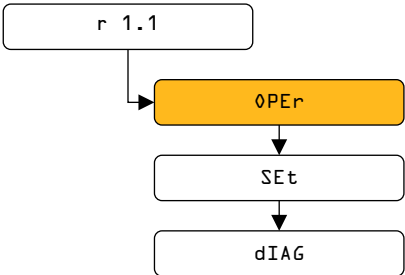
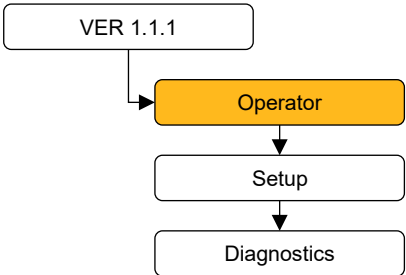

- Navigate to the '**Operator**' menu:

Top Level Menu Overview	
Onboard Keypad Display	6901 Remote Keypad Display
	

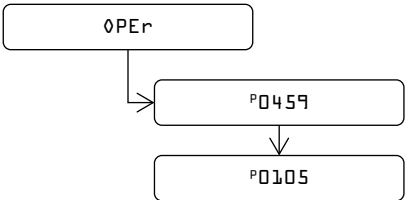
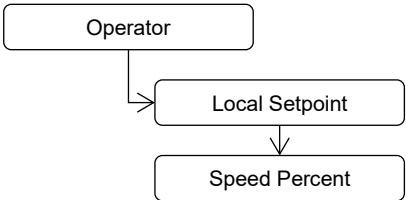





- Set the parameter **0459 (Local Setpoint)** to the desired speed setpoint (% of motor nameplate rpm):

'Operator' Menu Overview ('Local' Mode)	
Onboard Keypad Display	6901 Remote Keypad Display
	

- Press the '**Run**' key:

Local 'Run' Enable	
Onboard Keypad Display	6901 Remote Keypad Display
	



- The drive will enable and should accelerate the motor to the speed demanded. Parameter **0105 (Speed Percent)** provides the real time speed feedback (% of motor nameplate rpm) value.
- When the drive is running, the drive will show the following status indication:

Drive 'Running' Indication	
Onboard Keypad Display	6901 Remote Keypad Display
 <p>Motor 'Running' icon 'rotates' in the direction of the shaft.</p>	 <p>Motor 'Running' LED Illuminated, motor 'Stopped' LED off.</p> <p>The shaft will rotate in the direction indicated by the direction LEDs:</p> <p>'FWD' direction:  </p> <p>'REV' direction:  </p>



4. Stopping The Drive:

To stop the drive:

- Press the **'Stop'** key:

Local 'Stop' Mode Initiation	
Onboard Keypad Display	6901 Remote Keypad Display
	



The drive should decelerate the motor to a standstill, before disabling:

Drive 'Stopped' Indication	
Onboard Keypad Display	6901 Remote Keypad Display
 <p>Motor 'Running' icon will continue 'rotating' during motor deceleration, until the motor has come to a stop.</p>	 <p>Motor 'Stopped' LED will flash during motor deceleration, until the motor has come to a stop, when the 'Stopped' LED will illuminate.</p>





5. To Change Motor Direction:

To change the direction of the motor with the onboard keypad:

- Ensure the drive is in a **'Stopped'** state:
- Press the **'Stop'** key and either the **'Up'** (**Forward**) or **'Down'** (**Reverse**) key simultaneously:

Changing Motor Direction Initiation	
Onboard Keypad Display	6901 Remote Keypad Display
 	

The direction is indicated by:

Motor 'Direction' Indication	
Onboard Keypad Display	6901 Remote Keypad Display
<p>If 'Forward' direction is active:</p>  <p>When 'Running', icon will 'rotate' in 'Forward' direction.</p> <p>If 'Reverse' direction is active:</p>  <p>When 'Running', icon will 'rotate' in 'Reverse' direction.</p>	<p>If 'Forward' direction is active: 'FWD' LED will illuminate, 'REV' LED will turn off:</p>  <p>If 'Reverse' direction is active: 'REV' LED will illuminate, 'FWD' LED will turn off:</p> 

Note: The direction can be changed on the Remote keypad at any time (i.e., when drive is **'Running'** or is **'Stopped'**).



9.2 'Remote' Operation (Using Pre-Defined Macro's)

To run the drive 'remotely' (using either push-buttons, switches or PLC's as opposed to a keypad), the following steps need to be followed.



Note: This sequence assumes that the 'Basic Drive Setup' routine has been completed, as outlined above.

9.2.1 Enable 'Remote' Control Mode

To enable 'Remote' Control Mode:

Remote Control Mode Selection	
Onboard Keypad Display	6901 Remote Keypad Display
 <p>Press and hold the 'Stop' key for approx. 3 seconds as "C ... O ... L" disappears from the display.</p>	 <p>Press the 'L/R' key.</p>

Once 'Remote' Control Mode is enabled, the drive will show the following status indication:

Remote Control Mode 'Enabled'	
Onboard Keypad Display	6901 Remote Keypad Display
 <p>The hand icon will disappear from the display.</p>	 <p>The 'SEQ' & 'REF' LEDs will turn off.</p>

9.2.2 Selecting & Loading A Macro

To select and load a pre-defined Macro:

- Navigate through the 'Setup' menu, to the 'Application' sub-menu:

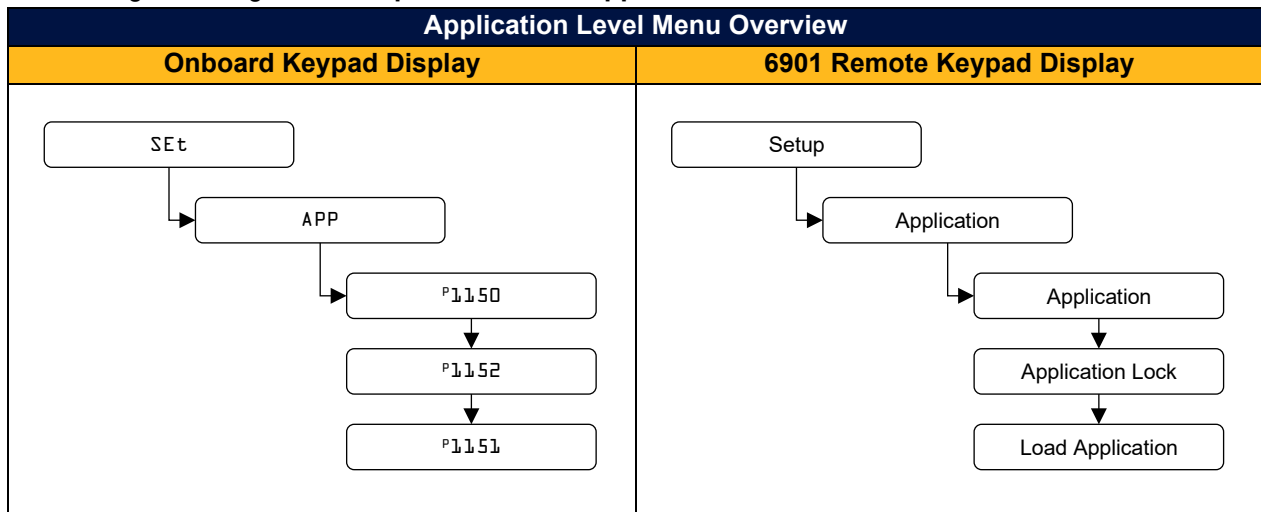

- Select an 'Application' (Macro) by changing the value of parameter **1150 (Application)**.
- Next, change parameter **1151 (Load Application)** from '0' to '1' (**FALSE** to **TRUE**) to load the application.

Parameter Name	No.	Default Value	Range	Units	Type	Writable
Application	1150	9: Saved	0: Null 1: Standard 2: Auto/Manual 3: Presets 4: Raise/Lower 5: PID 6: Aux Comms 9: Saved		ENUM	STOPPED
Application Lock	1152	FALSE			BOOL	ALWAYS
Load Application	1151	FALSE			BOOL	STOPPED

- To 'lock' the application so it can not be accidentally changed, set parameter **1152 (Application Lock)** from '0' to '1' (**FALSE** to **TRUE**).

9.2.3 Running The Drive

Providing the drive is:

1. Set to '**Remote**' operating mode.
2. '**Initial Drive Setup**' has been completed.
3. An '**Autotune**' routine has been completed (if set to SVC mode).

The drive is ready to be run from the remote switches (see application examples below):

9.2.4 Application '1': Standard (Basic Speed Control)

This Application is ideal for general purpose applications. It provides push-button or switched start/stop control. The setpoint is the sum of the two analogue inputs AIN1 and AIN2, providing Speed Setpoint + Speed Trim capability.

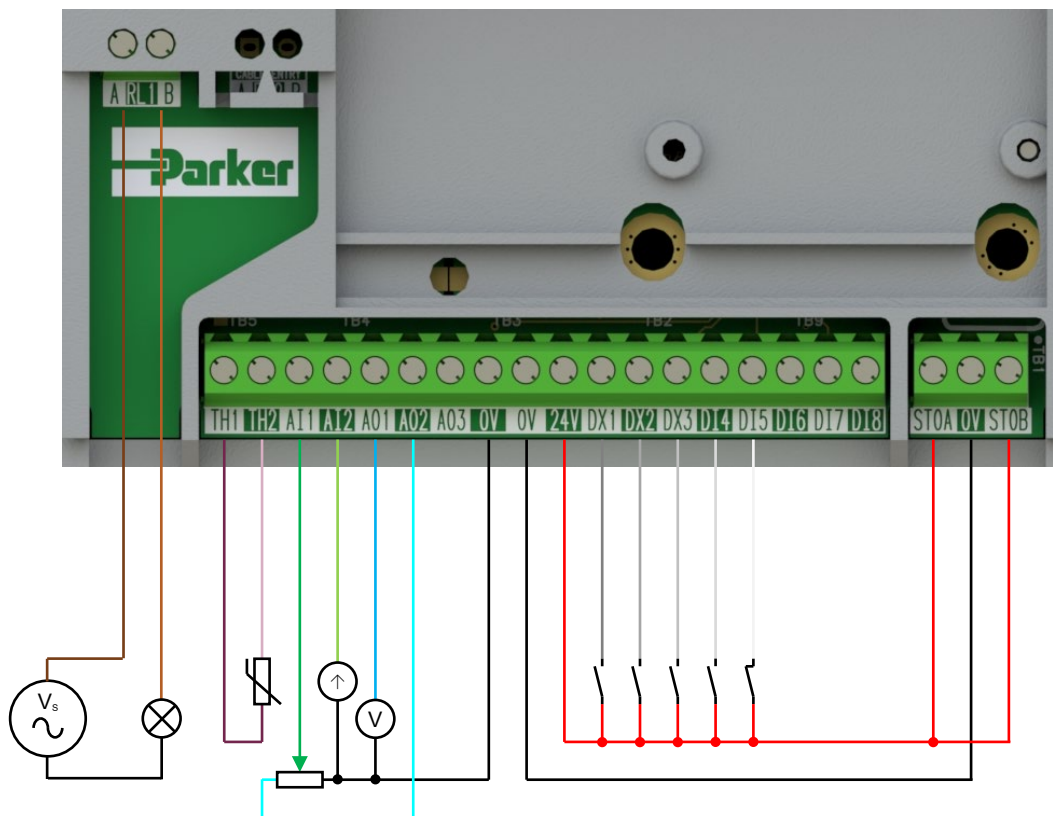

Configuration Setup:

RL1A	110-230Vac (or 24Vdc) voltage supply
RL1B	Healthy: Relay output (to lamp)
TH1	Motor Thermistor '+' connection
TH2	Motor Thermistor '-' connection
AI1	Remote Setpoint (%) – input 1: 0-10V variable input (from potentiometer)
AI2	Remote Setpoint 'Trim' (%) – input 2: 4-20mA variable input (from current source)
AO1	Speed Demand (%): 0-10V variable output (to voltmeter)
AO2	Value = 100%: 0-10V variable output (+10V fixed reference voltage)
DX1	Run Forward: 24V digital input
DX2	Remote Reverse: 24V digital input
DX3	Jog: 24V digital input
DI4	Not Stop: 24V digital input
DI5	Not Coast Stop: 24V digital input
STO	STO DISABLED (drive operational)

9.2.5 Application '2': Auto / Manual

Two Run inputs and two Setpoint inputs are provided. The Auto/Manual switch selects which pair of inputs is active.

The Application is sometimes referred to as Local/Remote.

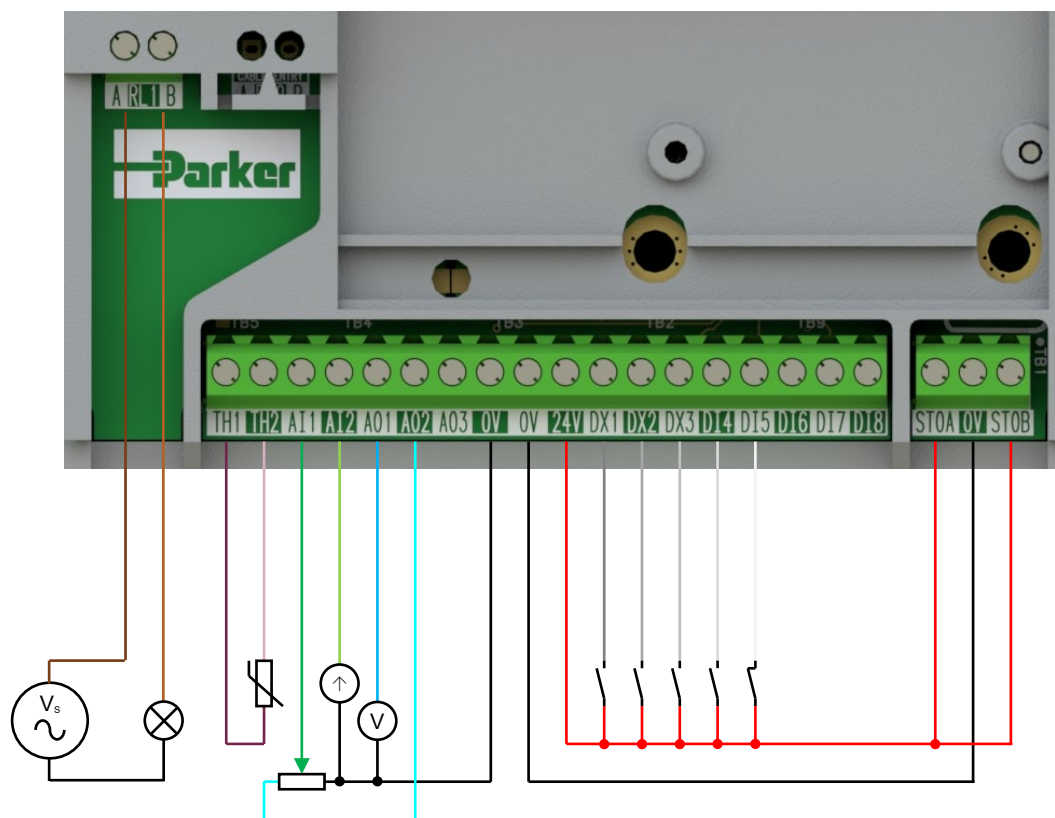

Configuration Setup:

RL1A	110-230Vac (or 24Vdc) voltage supply
RL1B	Healthy: Relay output (to lamp)
TH1	Motor Thermistor '+' connection
TH2	Motor Thermistor '-' connection
AI1	'Manual' Remote Setpoint (%): 0-10V variable input (from potentiometer)
AI2	'Auto' Remote Setpoint (%): 4-20mA variable input (from current source)
AO1	Speed Demand (%): 0-10V variable output (to voltmeter)
AO2	Value = 100%: 0-10V variable output (+10V fixed reference voltage)
DX1	'Manual' Run: 24V digital input
DX2	'Auto' Run: 24V digital input
DX3	Auto / Manual Select: 24V digital input
D14	Remote Reverse: 24V digital input
D15	Not Coast Stop: 24V digital input
STO	STO DISABLED (drive operational)

9.2.6 Application '3': Presets

This is ideal for applications requiring multiple discrete speed levels.

The setpoint is selected from either the sum of the analogue inputs, (as in Application 1 and known here as PRESET 0), or as one of up to seven other pre-defined speed levels. These are selected using DIN2, DIN3 and DIN4 as per the Truth Table below:

DX2 (Preset Select 1)	DX3 (Preset Select 2)	DI4 (Preset Select 3)	Preset Setpoint No.
0V	0V	0V	0
24V	0V	0V	1
0V	24V	0V	2
24V	24V	0V	3
0V	0V	24V	4
24V	0V	24V	5
0V	24V	24V	6
24V	24V	24V	7

The keypad can be used to re-define the speed levels of the PRESET 1 to PRESET 7 setpoints. Reverse direction is achieved by entering a negative speed setpoint.

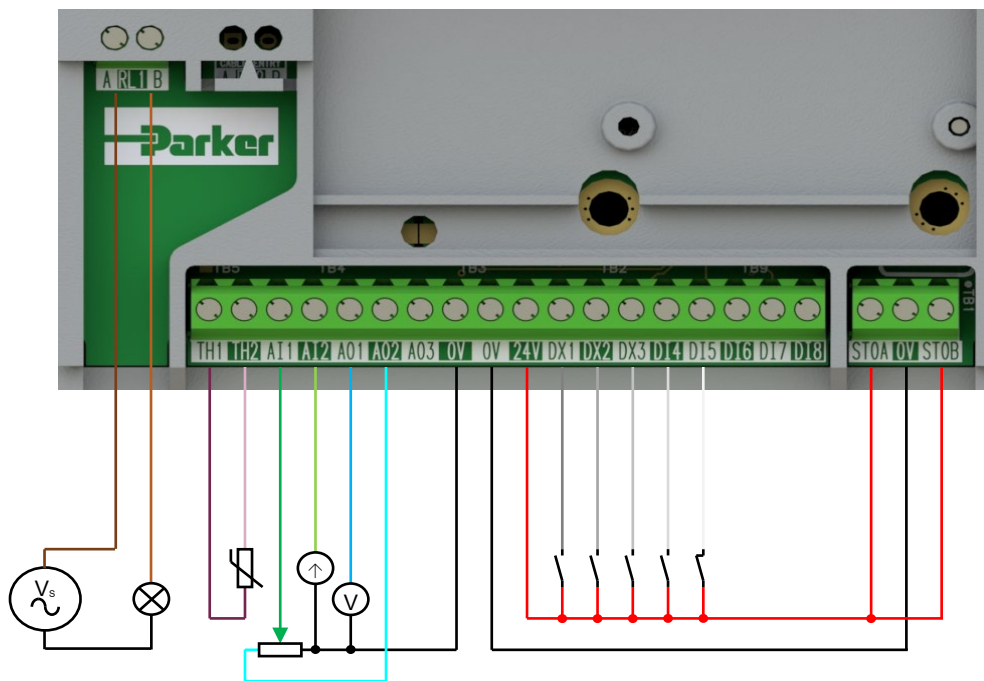

Configuration Setup:	
RL1A	110-230Vac (or 24Vdc) voltage supply
RL1B	Healthy: Relay output (to lamp)
TH1	Motor Thermistor '+' connection
TH2	Motor Thermistor '-' connection
AI1	Remote Setpoint (%) – input 1: 0-10V variable input (from potentiometer)
AI2	Remote Setpoint 'Trim' (%) – input 2: 4-20mA variable input (from current source)
AO1	Speed Demand (%): 0-10V variable output (to voltmeter)
AO2	Value = 100%: 0-10V variable output (+10V fixed reference voltage)
DX1	Run Forward: 24V digital input
DX2	Preset Select 1: 24V digital input
DX3	Preset Select 2: 24V digital input
DI4	Preset Select 3: 24V digital input
DI5	Not Coast Stop: 24V digital input
STO	STO DISABLED (drive operational)

9.2.7 Application '4': Raise / Lower

This Application mimics the operation of a motorised potentiometer. Digital inputs allow the setpoint to be increased and decreased between limits. The limits and ramp rate can be set using the keypad. The Application is sometimes referred to as Motorised Potentiometer.

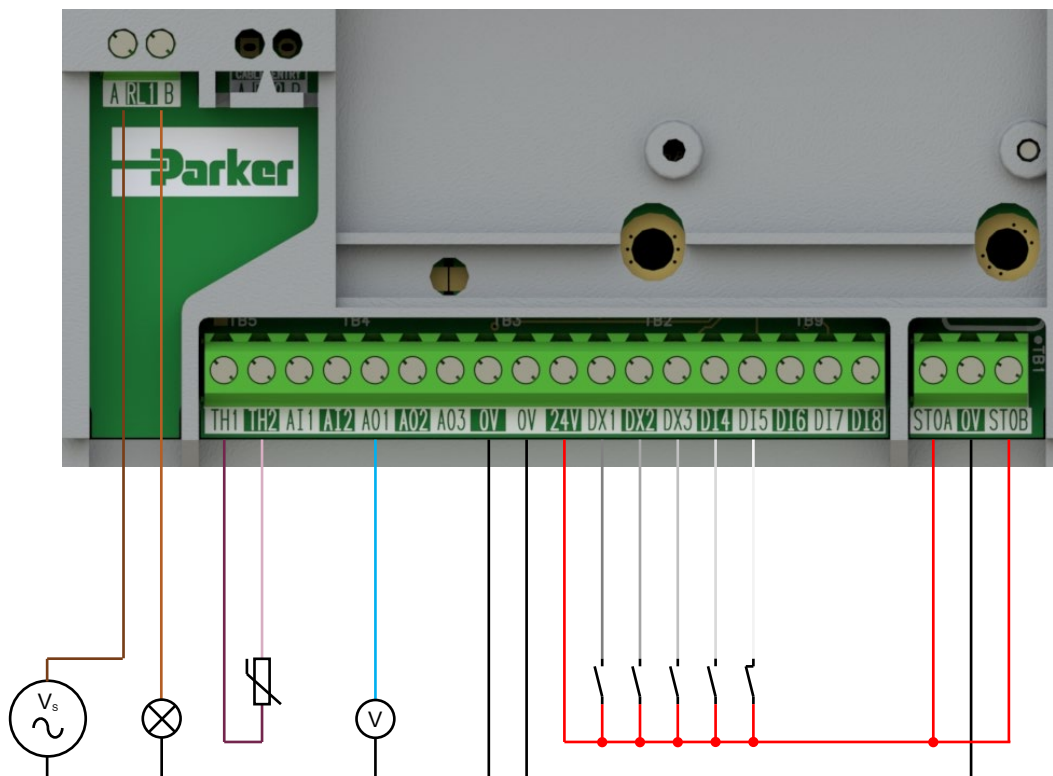

Configuration Setup:

RL1A	110-230Vac (or 24Vdc) voltage supply
RL1B	Healthy: Relay output (to lamp)
TH1	Motor Thermistor '+' connection
TH2	Motor Thermistor '-' connection
AO1	Speed Demand (%): 0-10V variable output (to voltmeter)
DX1	Run Forward: 24V digital input
DX2	Raise: 24V digital input
DX3	Lower: 24V digital input
D4	Raise / Lower Reset: 24V digital input
D5	Not Coast Stop: 24V digital input
STO	STO DISABLED (drive operational)

9.2.8 Application '5': PID

A simple application using a Proportional-Integral-Derivative 3-term controller. The setpoint is taken from AIN1, with feedback signal from the process on AIN2. The scale and offset features of the analogue input blocks may be used to correctly scale these signals. The difference between these two signals is taken as the PID error. The output of the PID block is then used as the drive setpoint.

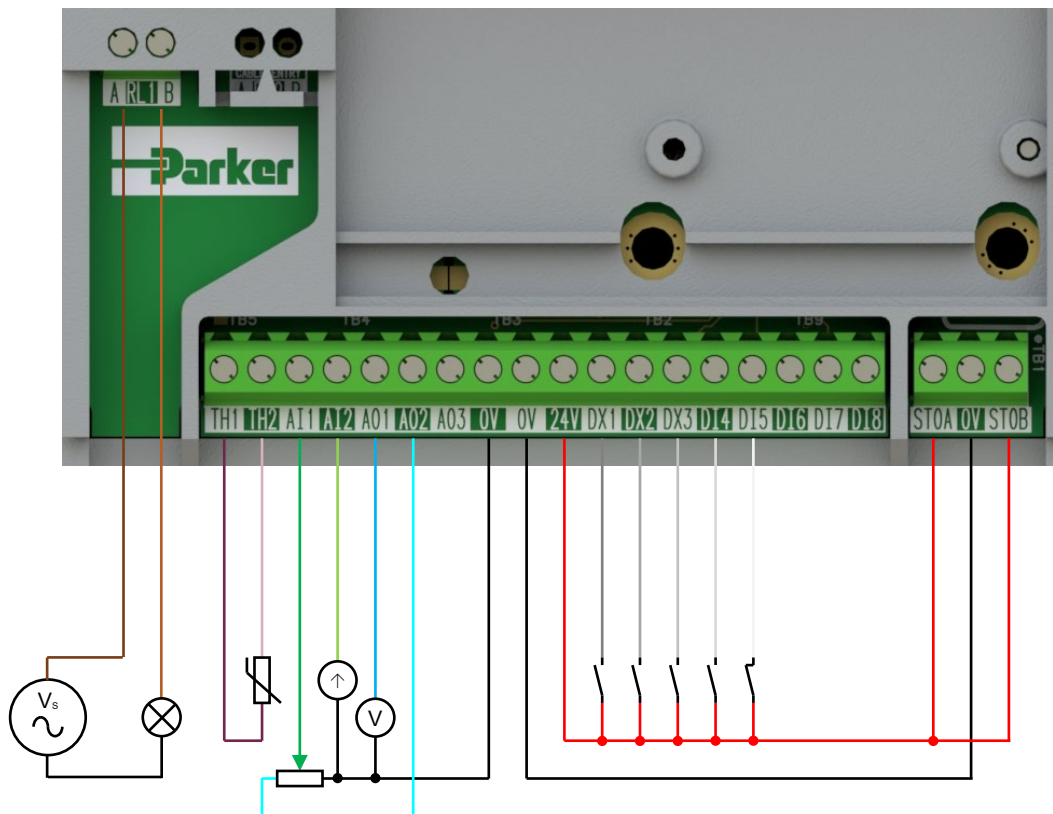

Configuration Setup:	
RL1A	110-230Vac (or 24Vdc) voltage supply
RL1B	Healthy: Relay output (to lamp)
TH1	Motor Thermistor '+' connection
TH2	Motor Thermistor '-' connection
AI1	Process Setpoint (%) – input 1: 0-10V variable input (from potentiometer)
AI2	Process Feedback (%) – input 2: 4-20mA variable input (from current source)
AO1	Speed Demand (%): 0-10V variable output (to voltmeter)
AO2	Value = 100%: 0-10V variable output (+10V fixed reference voltage)
DX1	Run Forward: 24V digital input
DX2	Remote Reverse: 24V digital input
DX3	Jog: 24V digital input
DI4	Not Stop: 24V digital input
DI5	Not Coast Stop: 24V digital input
STO	STO DISABLED (drive operational)

9.2.9 Application '6': Aux Comms

Aux Comms is designed to reproduce the Aux Comms macro/template from the legacy 650 range of drives. The default method of communications for this macro is Modbus TCP/IP, and the master controller must be configured with a mapping that connects to the points shown in red text within the DSELite template.

Refer to the 'AC15 Series – Software Reference' Manual (DOC-0017-05) for instructions on configuring base Modbus TCP/IP communications.

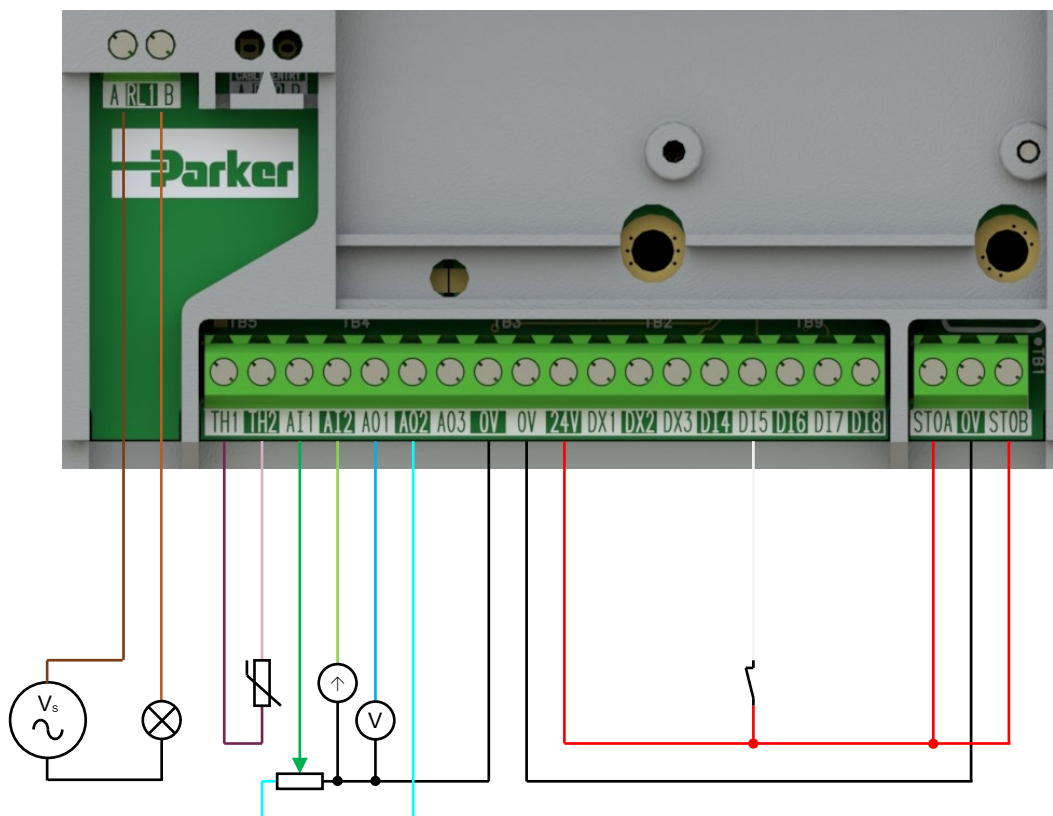

Configuration Setup:	
RL1A	110-230Vac (or 24Vdc) voltage supply
RL1B	Healthy: Relay output (to lamp)
TH1	Motor Thermistor '+' connection
TH2	Motor Thermistor '-' connection
AI1	Remote Setpoint (%) – input 1: 0-10V variable input (from potentiometer)
AI2	Remote Setpoint 'Trim' (%) – input 2: 4-20mA variable input (from current source)
AO1	Speed Demand (%): 0-10V variable output (to voltmeter)
AO2	Value = 100%: 0-10V variable output (+10V fixed reference voltage)
DI5	Not Coast Stop: 24V digital input
STO	STO DISABLED (drive operational)

10 Routine Maintenance & Repair

10.1 Routine Maintenance

Periodic inspection of the drive should check:

1. For build up of dust obstructions that may obstruct the ventilation of the product. This should be removed using dry air.
2. Tightness of power connections are at the recommended terminal tightening torque as specified in this manual.

10.2 Preventative Maintenance

10.2.1 Main Duct Cooling Fans

The Main Duct Cooling fans are designed to be field replaceable by a competent person.

For preventative maintenance, replace the fan cassettes every 5 years of operation, or whenever the drive trips on “tr10” / “10 Heatsink Temp” during normal operation.

10.2.2 DC Link Capacitors

For preventative maintenance, the DC link capacitors should be replaced every 10 years of operation, or when the drive trips on “tr20” / “20 VDC Ripple” under normal operating conditions.

The unit must be returned to your local Parker Repair Centre for replacement.

10.3 Repair

In the event of a drive failure, the drive should be returned to a local Parker Repair Centre. No attempt should be made by the user to repair the unit themselves. Only Parker trained personnel are permitted to repair this product in order to maintain certifications, reliability, and quality levels.

When returning a faulty product, the user should:

1. Where possible, save the application data onto either a µSD card using the ‘Clone’ feature, or onto a PC by performing a configuration ‘Extraction’ using the DSE configuration tool.
2. Contact the local Repair Centre, who will arrange the return of the unit and assign an Authorisation To Return (ATR) number. This is used as a reference on all paperwork returned with the faulty item.
Customers should be ready with the following information:

- Product model and serial number (found on the product rating label)
- Detailed information on the nature of the fault (Trip messages, user application and history).

3. Pack and dispatch the unit using original packaging materials where retained, or in suitable packaging materials that ensure that no additional damage is caused to the unit during transit.

Please ensure that if used, packing chips do not enter the unit.

11 Compliance

11.1 Applicable Standards



Standard No.	Title / Description
EN 61800-3:2018	Adjustable speed electrical power drive systems <i>Part 3: EMC requirements and specific test methods.</i>
EN 61800-5-1:2007+A11:2021	Adjustable speed electrical power drive systems <i>Part 5-1: Safety requirements – Electrical, thermal and energy.</i>
EN 61800-5-2:2017	Adjustable speed electrical power drive systems <i>Part 5-2: Safety requirements – Functional.</i>
EN ISO 13849-1:2015	Safety of machinery – Safety-related parts of control systems <i>Part 1: General principles for design</i>
EN 60204-1:2018	Safety of machinery – Electrical equipment of machines <i>Part 1: General requirements.</i>
EN 61000-3-2:2019+A1:2021	Electromagnetic Compatibility (EMC) <i>Part 3-2: Limits – Limits for harmonic current emissions (equipment input current up to and including 16A per phase).</i>
EN62061:2005 Annex E+A2:2015	Safety of machinery <i>Functional safety of safety related electrical, electronic and programmable electronic control systems.</i>
IEC 61000-3-12:2011+AMD1:2021	Electromagnetic compatibility (EMC) <i>Part 3-12: Limits – Limits for harmonic currents produced by equipment connected to public low-voltage systems with input currents >16A and '575A per phase.</i>
BS EN IEC 61000-6-2:2019	Electromagnetic compatibility (EMC) <i>Part 6-2: General standards – Immunity for industrial environments.</i>
BS EN IEC 61000-6-3:2021	Electromagnetic compatibility (EMC) <i>Part 6-3: General standards - Emission standard for residential, commercial and light-industrial environments.</i>
BS EN IEC 61000-6-4:2019	Electromagnetic compatibility (EMC) <i>Part 6-4: General standards – Emission standard for residential, commercial and light-industrial environments.</i>
UL61800-5-1	Adjustable speed electrical power drive systems <i>Part 5-1: Safety requirements – Electrical, thermal and energy. Edition 1</i>
CSA 22.2 No.274	Adjustable speed drives <i>2nd Edition April 2017</i>
NFPA	National Electrical Code, National Fire Protection Agency <i>Part 70</i>

11.2 European Compliance

11.2.1 CE Marking



The CE marking is placed upon the product by Parker Hannifin Manufacturing to facilitate its free movement within the European Economic Area (EEA). The CE marking provides a presumption of conformity to all applicable directives. Harmonized standards are used to demonstrate compliance with the essential requirements laid down in those relevant directives.

It must be remembered that there is no guarantee that combinations of compliant components will result in a compliant system. This means that compliance to harmonised standards will have to be demonstrated for the system as a whole to ensure compliance with the directive.

	WARNING! Local wiring regulations always take precedence. Where there are any conflicts between regulatory standards - for example, earthing requirements for electromagnetic compatibility, safety shall always take precedence.	
---	--	---

Low Voltage Directive

When installed in accordance with this manual, the product will comply with the low voltage directive 2014/35/EU.

	PROTECTIVE EARTH (PE) CONNECTIONS Only one protective earth  conductor is permitted at each protective earth terminal contacting point.	
---	--	---

Unless local wiring guidelines state otherwise, the minimum PE earth conductor should be as follows:

Cross-sectional area of phase conductors 'S' (mm ²)	Minimum cross-sectional area of PE conductor 'S _P ' (mm ²)
$S \leq 16$	S
$16 < S \leq 35$	16
$35 < S$	$S / 2$

Note: Values in table assume PE conductor is the same material as the phase conductors

If the PE earth conductor size according to the table above is $< 10\text{mm}^2$ (8 AWG) copper Cu conductor, a second protective earth connection using a conductor of the same cross-sectional area as the original must be added. This is due to the current flowing in the Y-Caps being $> 3.5\text{mA}$.



EMC Directive

When installed in accordance with this manual the product will comply with the electromagnetic compatibility directive 2014/30/EU.

The following information is provided to maximise the Electro Magnetic Compatibility (EMC) of VSDs and systems in their intended operating environment, by minimising their emissions and maximising their immunity.

Machinery Directive

When installed in accordance with this manual the product will comply with the machinery directive 2006/42/EC.

	WARNING! This product is classified under category 21 of annex IV as 'logic units to ensure safety functions'. All instructions, warnings and safety information can be found in 'Chapter 8: Safe Torque Off (STO): SIL2/PLd'. This product is a component to be incorporated into machinery and may not be operated alone. The complete machinery or installation using this equipment may only be put into service when all safety considerations of the Directive are fully implemented. Particular reference should be made to EN60204-1 (Safety of Machinery - Electrical Equipment of Machines).	
---	--	---

11.2.2 EMC Compliance

A list of EMC Compliance definitions relevant to this section are listed in the table below:

Terminology	Description
Environment	
First Environment:	Environment that includes domestic premises, it also includes establishments directly connected without transformers to a low-voltage power supply network which supplies buildings used for domestic purposes. Note: Houses, apartments, commercial premises or offices in a residential building are examples of first environment locations.
Second Environment:	Environment that includes all establishments other than those directly connected to a low-voltage power supply network which supplies buildings used for domestic purposes. Note: Industrial areas, technical areas of any building fed from a dedicated transformer are examples of second environment locations.
Category	
Category C1:	PDS (Power Drive System) of rated voltage less than 1000V, intended for use in the first environment.
Category C2:	PDS (Power Drive System) of rated voltage less than 1000V, which is neither a plug-in device nor a movable device and, when used in the first environment, is intended to be installed and commissioned only by a professional. Note: A professional is a person or an organisation having necessary skills in installing and/or commissioning power drive systems, including their EMC aspects.
Category C3:	PDS (Power Drive System) of rated voltage less than 1000V, intended for use in the second environment and not intended for use in the first environment.
Category C4:	PDS (Power Drive System) of rated voltage equal to or above 1000V, or rated current equal to or above 400A, or intended for use in complex systems in the second environment.

11.2.3 EMC Standards

The EMC standards are concerned with two types of emission:

- Radiated:**
Those in the band 30MHz – 1000MHz which radiate into the environment.
- Conducted:**
Those in the band 150kHz – 30MHz which are injected into the supply.

Radiated Emissions: Standards

The Radiated Emissions standards have common roots (CISPR 11 & CISPR14), so there is some commonality in the test levels applied in different environments as shown in the table below:

Standards			Limits*	
Product Specific	Generic		Frequency (MHz)	dB(µV/m)
EN 61800-3	EN61000-6-3	EN61000-6-4		
Category C1	Equivalent	Not applicable	30 - 230	30
			230 - 1000	37
Category C2	Not applicable	Equivalent	30 - 230	40
			230 - 1000	47

Standards			Limits*	
Product Specific	Generic		Frequency (MHz)	dB(μ V/m)
EN 61800-3	EN61000-6-3	EN61000-6-4		
Category C3	These limits have no relationships with the generic standards.		30 - 230	50
			230 - 1000	60
<p>* = Limit has been adjusted for a measurement distance of 10m.</p> <p>For category C1, if the field strength measurement at 10m cannot be made because of high ambient noise levels or for other reasons, the measurement may be made at 3m.</p> <p>If the 3m distance is used, the measurement result obtained shall be normalised to 10m by subtracting 10dB from the result.</p> <p>In this case, care should be taken to avoid near field effects, particularly when the PDS (Power Drive System) is not of an appropriately small size, and at frequencies near 30MHz.</p> <p>When multiple drives are used, 3dB attenuation per drive needs to be added.</p>				



Conducted Emissions: Standards

The Conducted Emissions standards have common roots (CISPR 11 & CISPR14), so there is some commonality in the test levels applied in different standards and environments as shown in the table below:

Standards			Limits*		
Product Specific	Generic		Frequency (MHz)	Quasi Peak (dB/ μ V)	Average (dB/ μ V)
EN 61800-3	EN61000-6-3	EN61000-6-4			
Category C1	Equivalent	Not applicable	0.15 - 0.5	66 > 56 [†]	56 > 46 [†]
			0.5 - 5.0	56	46
			5.0 - 30.0	60	50
Category C2	Not applicable	Equivalent	0.15 - 0.5	79	66
			0.5 - 5.0	73	60
			5.0 - 30.0	73	60
Category C3 (I \leq 100A)	These limits have no relationships with the generic standards.		0.15 - 0.5	100	90
			0.5 - 5.0	86	76
			5.0 - 30.0	90 > 70 [†]	80 > 60 [†]
Category C3 (I \geq 100A)	These limits have no relationships with the generic standards.		0.15 - 0.5	130	120
			0.5 - 5.0	125	115
			5.0 - 30.0	115	105



[†] = Limit decreases with the Log of frequency for the specified frequency range

Radiated & Conducted Emissions: Compliance Overview

	WARNING!	
In a domestic environment, this product may cause radio interference, in which case supplementary mitigation measures may be required.		

EN 61800-3	Category C1	Category C2	Category C3
Radiated Emissions			
Frame 1	n / a	n / a	Should be mounted inside a cubicle with the required attenuation between: 30 – 45MHz @ 8dB
Frame 2			
Frame 3			
Frame 4			
Frame 5			
Conducted Emissions			
Frame 1	External EMC Filter required. See emissions plots below.	External EMC Filter required. See emissions plots below.	Internal EMC Filter Maximum motor cable length 25m
Frame 2			
Frame 3			
Frame 4			
Frame 5			

Conducted emission solutions true for default switching frequency of drive. Operation at higher switching frequencies will require extra filtering.

WARNING!		
	<p>The drive is suitable for use on TN supplies when fitted with the internal filter. When used on an IT supply, all Y-cap connections to earth need to be removed, hence the filter effectiveness is reduced.</p> <p>Refer to 'Chapter 6: Installation' for details on how to remove the Y-cap and VDR disconnects when installing the product on an IT supply.</p>	

Conducted Emissions Plots

Where a solution is required that is not met by the AC15 product range offering, filtered emissions plots have been provided to allow specialist EMC filter design companies to tailor a design to meet the customer's needs.

Notes on Conducted Emissions Plots:

- Plot is of 'worst' line phase of largest power rating, of a given frame size.
- All tests carried out with an unloaded motor.
- Shielded motor cable, 25m in length was used.
- All filter capacitors were connected in circuit (i.e., Y-Caps) for each test.

1ø, 230V Products:

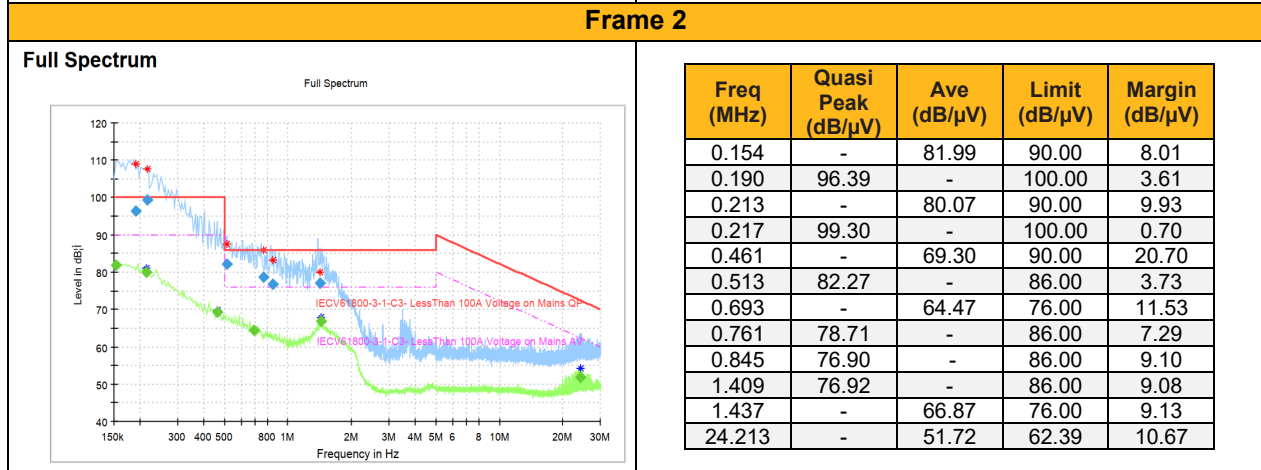
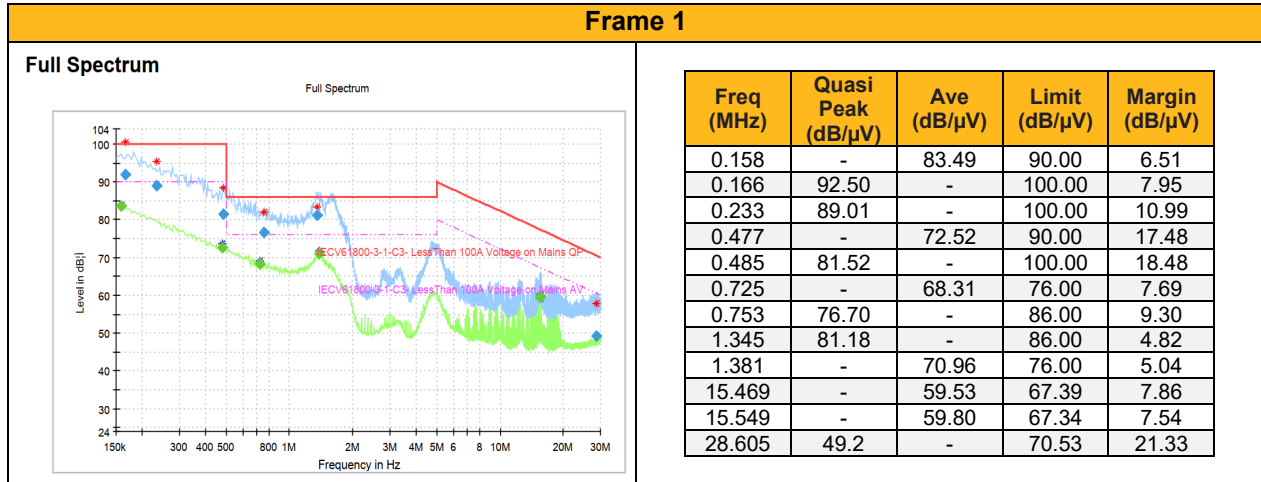

3ø, 230V Products:

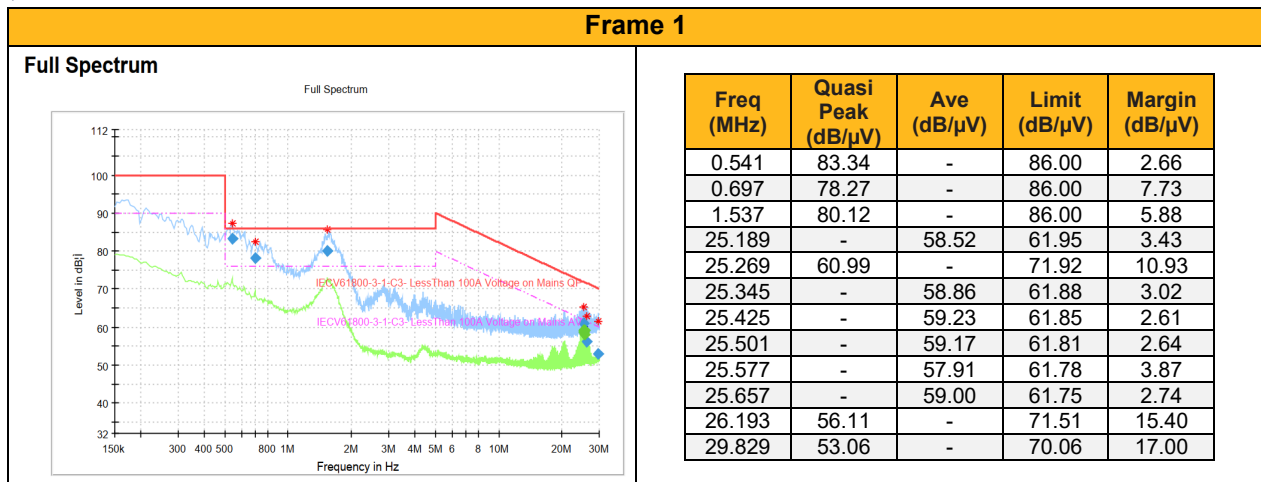

Frame 2

Full Spectrum

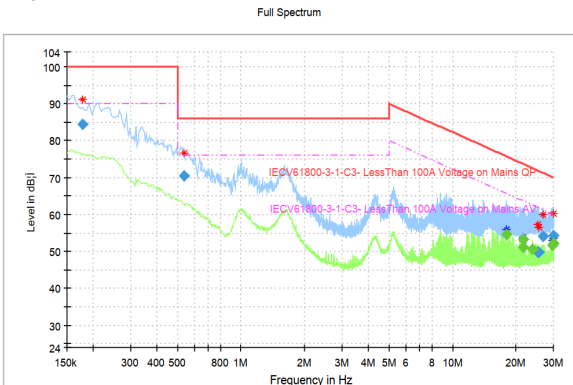

Freq (MHz)	Quasi Peak (dB/μV)	Ave (dB/μV)	Limit (dB/μV)	Margin (dB/μV)
0.178	84.46	-	100.00	15.54
0.537	70.52	-	86.00	15.48
17.921	-	54.68	65.75	11.07
21.457	-	51.24	63.74	12.51
21.533	-	53.19	63.70	10.51
23.969	-	50.67	62.51	11.83
25.193	49.71	-	71.95	22.24
25.477	49.87	-	71.82	21.95
26.721	53.97	-	71.29	17.33
29.789	-	51.59	60.08	8.49
29.869	54.41	-	70.05	15.63
29.945	-	52.19	60.02	7.83

Frame 3

Full Spectrum

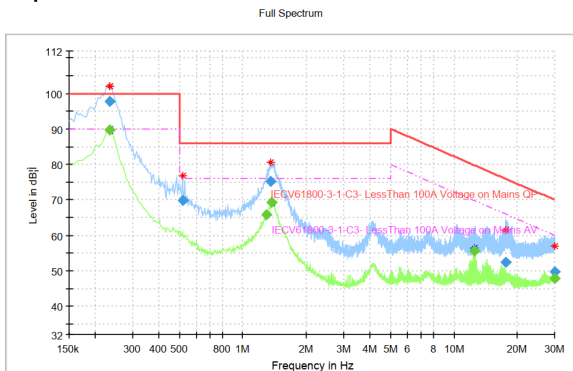

Freq (MHz)	Quasi Peak (dB/μV)	Ave (dB/μV)	Limit (dB/μV)	Margin (dB/μV)
0.233	-	89.66	90.00	0.34
0.233	97.87	-	100.00	2.13
0.521	69.82	-	86.00	16.18
1.289	-	65.77	76.00	10.23
1.345	75.27	-	86.00	10.73
1.361	-	69.23	76.00	6.77
12.453	-	55.53	69.81	14.28
17.505	52.28	-	76.01	23.73
29.981	-	47.84	60.01	12.17
29.993	49.84	-	70.00	20.16

Frame 4

Full Spectrum

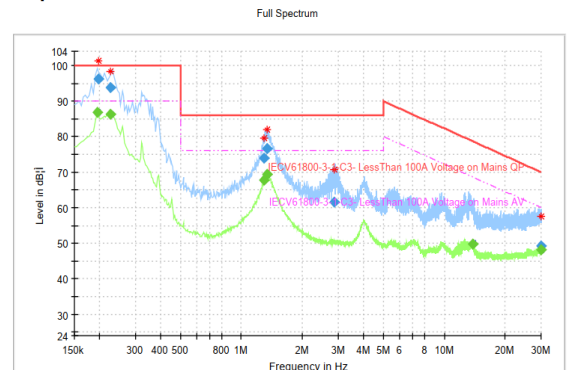

Freq (MHz)	Quasi Peak (dB/μV)	Ave (dB/μV)	Limit (dB/μV)	Margin (dB/μV)
0.194	-	86.74	90.00	3.26
0.198	96.33	-	100.00	3.67
0.225	-	86.27	90.00	3.73
0.225	93.91	-	100.00	6.09
1.285	73.82	-	86.00	12.18
1.291	-	67.87	76.00	8.13
1.337	76.53	-	86.00	9.47
1.337	-	69.44	76.00	6.56
2.873	61.48	-	86.00	24.52
13.785	-	49.81	68.68	18.87
29.909	49.18	-	70.03	20.86
29.937	-	48.06	60.02	11.97

Frame 5

Full Spectrum

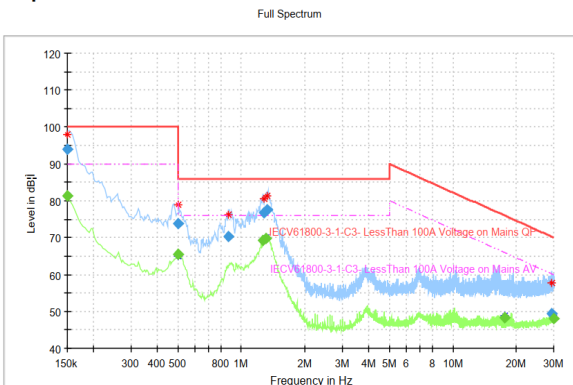

Freq (MHz)	Quasi Peak (dB/μV)	Ave (dB/μV)	Limit (dB/μV)	Margin (dB/μV)
0.150	-	81.21	90.00	8.79
0.150	93.84	-	100.00	6.16
0.501	-	65.53	76.00	10.47
0.501	73.81	-	86.00	12.19
0.869	70.24	-	86.00	15.76
1.269	-	69.33	76.00	6.67
1.277	76.71	-	86.00	9.29
1.301	-	69.81	76.00	6.19
1.329	77.47	-	86.00	8.53
17.649	-	48.42	65.92	17.51
29.261	49.42	-	70.28	20.86
29.905	-	47.98	60.04	12.05

3ø, 480V Products:

Frame 1

Full Spectrum

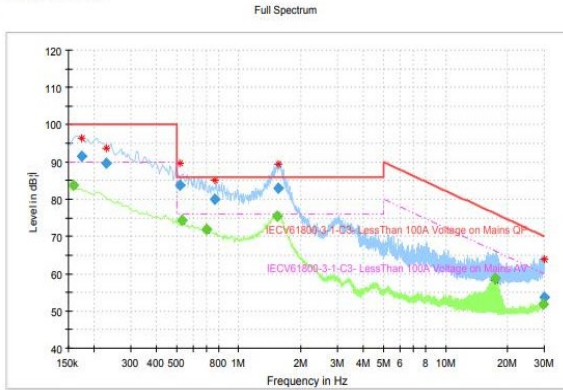

Freq (MHz)	Quasi Peak (dB/μV)	Ave (dB/μV)	Limit (dB/μV)	Margin (dB/μV)
0.158	-	83.77	90.00	6.23
0.174	91.42	-	100.00	8.58
0.229	89.54	-	100.00	10.46
0.517	83.87	-	86.00	2.13
0.533	-	74.27	76.00	1.73
0.701	-	71.83	76.00	4.17
0.761	79.93	-	86.00	6.07
1.529	-	75.38	76.00	0.62
1.553	83.06	-	86.00	2.94
17.337	-	58.72	66.12	7.41
29.657	-	51.72	60.13	8.41
29.977	53.71	-	70.01	16.30

Frame 2

Full Spectrum

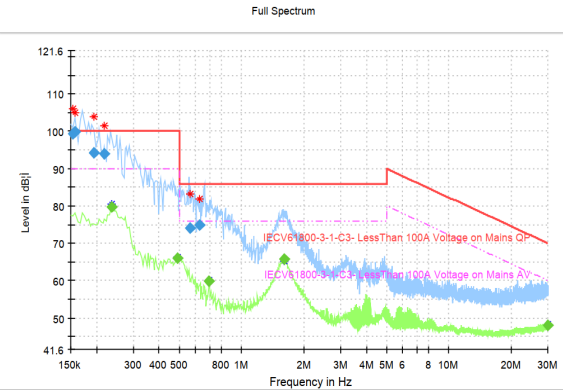

Freq (MHz)	Quasi Peak (dB/μV)	Ave (dB/μV)	Limit (dB/μV)	Margin (dB)
0.154	99.43	-	100.00	0.57
0.158	99.93	-	100.00	0.07
0.193	94.19	-	100.00	5.81
0.217	93.88	-	100.00	6.12
0.237	-	79.65	90.00	10.35
0.489	-	65.92	90.00	24.08
0.565	74.08	-	86.00	11.92
0.629	74.77	-	86.00	11.23
0.697	-	59.74	76.00	16.26
1.597	-	65.80	76.00	10.20
29.937	-	48.08	60.02	11.95

Frame 3

Full Spectrum

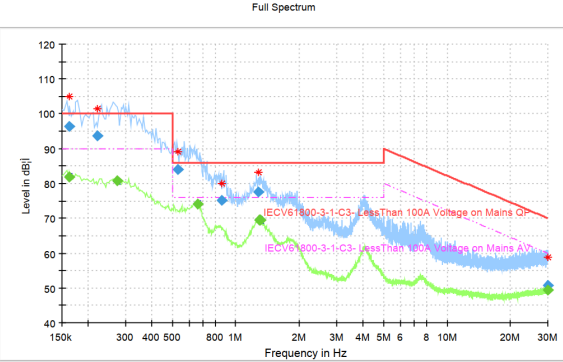

Freq (MHz)	Quasi Peak (dB/μV)	Ave (dB/μV)	Limit (dB/μV)	Margin (dB/μV)
0.162	-	81.79	90.00	8.21
0.162	96.38	-	100.00	3.62
0.221	93.81	-	100.00	6.19
0.273	-	80.84	90.00	9.16
0.529	84.01	-	86.00	1.99
0.661	-	74.11	76.00	1.89
0.857	75.16	-	86.00	10.84
1.273	77.47	-	86.00	8.53
1.289	-	69.42	76.00	6.58
1.305	-	69.60	76.00	6.40
29.913	50.72	-	70.03	19.32
29.959	-	49.51	60.02	10.51

Frame 4

Full Spectrum

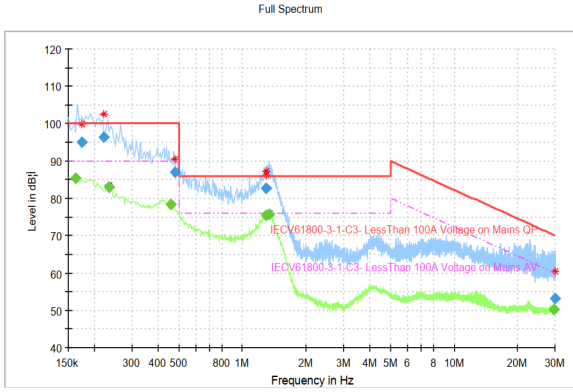

Freq (MHz)	Quasi Peak (dB/μV)	Ave (dB/μV)	Limit (dB/μV)	Margin (dB/μV)
0.162	-	85.27	90.00	4.73
0.174	95.10	-	100.00	4.90
0.221	96.35	-	100.00	3.65
0.233	-	83.01	90.00	6.99
0.457	-	78.27	90.00	11.73
0.481	87.10	-	100.00	12.90
1.287	-	75.40	76.00	0.60
1.289	82.78	-	86.00	3.22
1.293	82.60	-	86.00	3.40
1.333	-	75.83	76.00	0.17
29.805	-	50.14	60.07	9.94
29.873	53.26	-	70.05	16.79

Frame 5

Full Spectrum

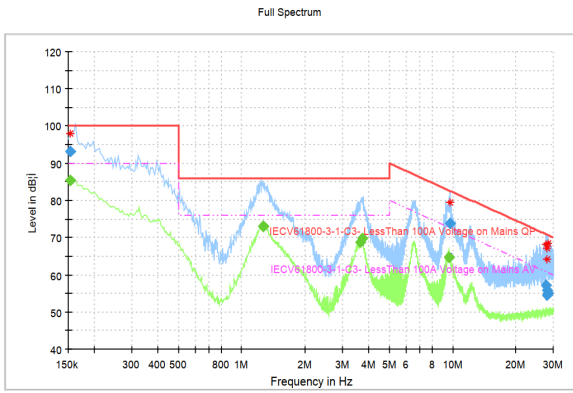

Freq (MHz)	Quasi Peak (dB/μV)	Ave (dB/μV)	Limit (dB/μV)	Margin (dB/μV)
0.154	---	85.39	90.00	4.61
0.154	93.16	---	100.00	6.84
1.261	---	73.13	76.00	2.87
1.265	---	73.06	76.00	2.94
3.631	---	68.6	76.00	7.40
3.725	---	69.77	76.00	6.23
9.625	---	64.8	72.69	7.89
9.669	73.94	---	82.64	8.70
27.649	57.2	---	70.91	13.71
27.921	55.74	---	70.80	15.06
28.069	54.51	---	70.74	16.24
28.357	55.05	---	70.63	15.58

11.2.4 EMC Installation Guidance

Protective Earth (PE) Connections

WARNING!

Local wiring regulations take precedence and may require the protective earth connection of the motor to be connected locally, i.e., not as specified in these instructions. This will not cause shielding problems because of the relatively high RF impedance of the local earth connection.

When installing an AC15 in a control cubicle, Parker recommends using a star-point earthing method where 'noisy' and 'clean' earths are separated out. Four separate earth bus bars, three of which are insulated from the mounting panel, connect to a single earth point (star point) near the incoming safety earth from the main supply:

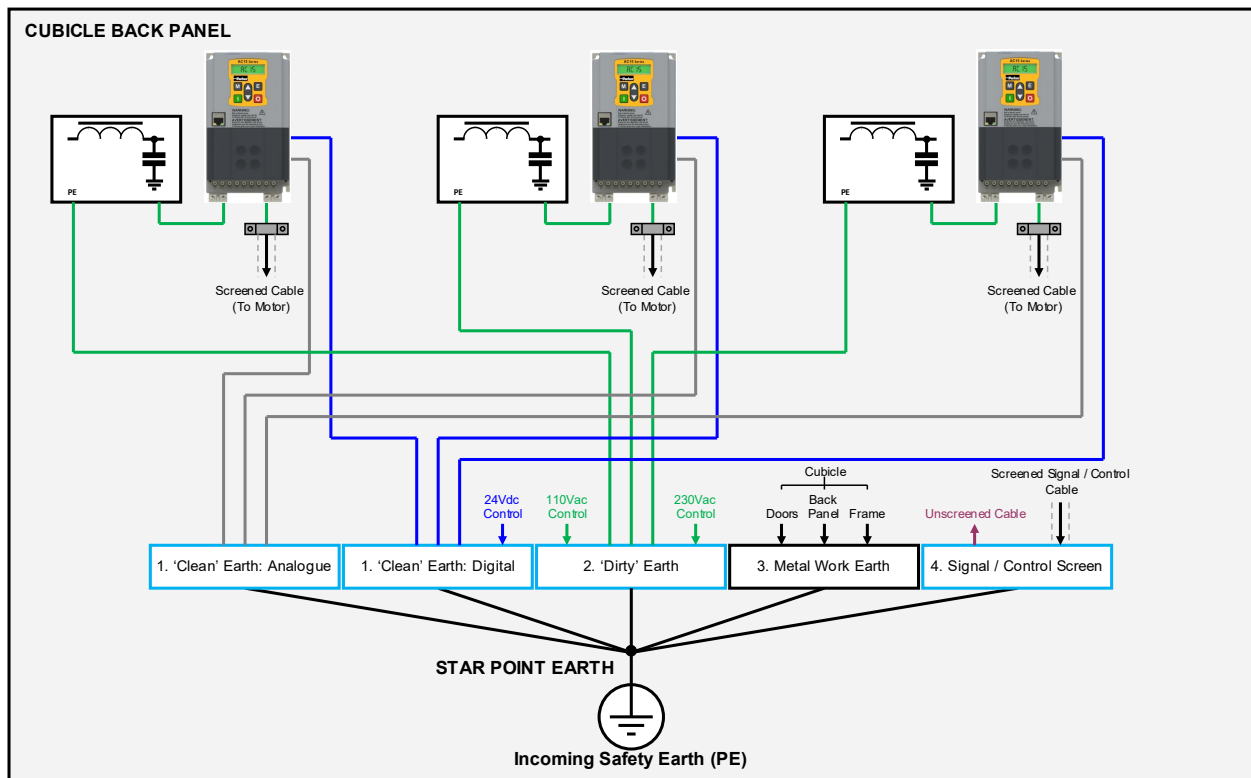

Key:

- 'CLEAN' Analogue Earth Cables
- 'CLEAN' Digital Earth Cables
- 'DIRTY' Earth Cables
- Enclosure Earth Cables
- Unscreened Signal Cables
- Screened Multi-Core Cables
- U-Clip Connected to Back Panel
- Busbar Insulated from Back Panel
- Busbar Connected to Back Panel

1. Clean Earth Busbar (insulated from the mounting panel):

- Used as a reference point for all signal and control cabling.
- It may be further subdivided into an analog and a digital reference busbar, each separately connected to the star earthing point.
- The digital reference is also used for any 24V control.
- Control / Signal, Encoder, Analogue Input and Communication cables require screening, with the screen connected at the drive end **only**.
However, if high frequency noise is a problem, earth the screen at the non-drive end via a 0.1 μ F capacitor, and move the screen connect at the drive end from the control board terminals to the protective earth point. \oplus

2. Dirty Earth Busbar (insulated from the mounting panel):

- Used for all power earths, i.e., protective earth connections.
- It is also used as a reference for any 110 or 220V control used, and for the control transformer screen.

3. Metal Work Earth Busbar:

- The control cubicle mounting panel is used as this earth busbar and should provide earthing points for all parts of the cubicle including panels and doors.
- This busbar is also used for power screened cables that terminate near to (\approx 10cm), or directly into an drive, such as Motor cables, Dynamic Brake Resistor cables (and resistors themselves), or connections between drive.
- Use U-clips to clamp the screened cables to the back panel to ensure optimum HF connection.

4. Signal / Control Screen Earth Busbar (insulated from the mounting panel):

- Used for signal/control screened cables which do not go directly to the drive.
- Place this busbar as close as possible to the point of cable entry.
- 'U' clamp the screened cables to the busbar to ensure an optimum HF connection.

Flexible, large cross-section cable or braids should be used to ensure low HF impedance.

Bus bars should be arranged so that the connections to the single earth point is as short as possible.

Cabling Requirements

Cables used for connecting to drive, can be termed as electrically 'Clean', 'Noisy' or 'Sensitive'. The diagram below shows an overview:

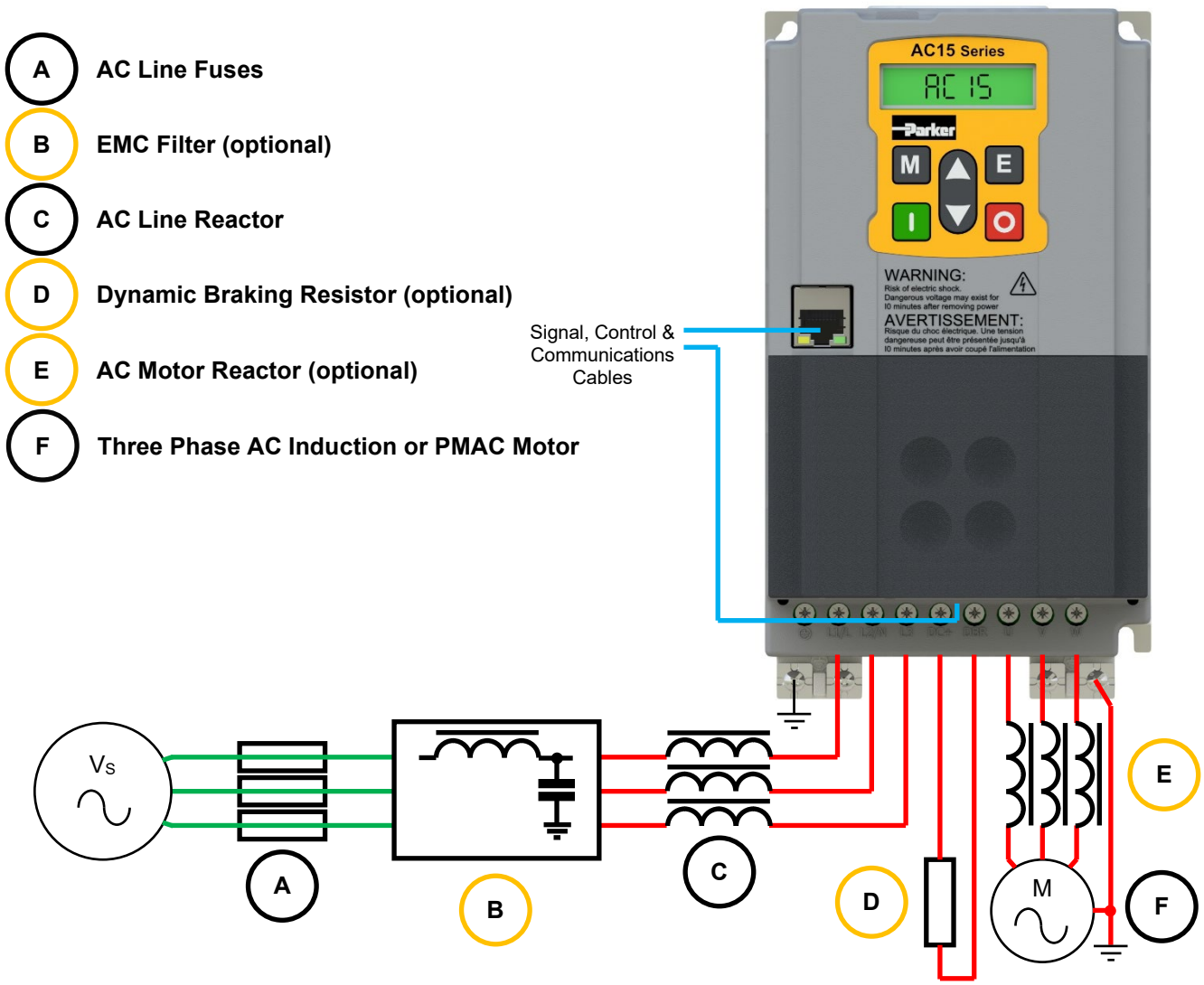

V_s = AC Voltage Source:

- 1ø, 220-240V
- 3ø, 220-240V
- 3ø, 380-480V

Supply & Power Cables

Key:

- 'CLEAN' Cables
- 'NOISY' Cables
- 'SENSITIVE' Cables

Cable routing should be planned in a way that segregates certain cable types to meet EMC compliance:

- Use the shortest possible motor cable lengths.
- When connecting multiple motors to a single drive, use a star junction point for motor cable connections. Use a metal box with entry and exit cable glands to maintain shield integrity.
- Keep electrically 'noisy' and 'sensitive' cables apart.
- Keep electrically 'noisy' and 'sensitive' parallel cable runs to a minimum. Separate parallel cable runs by at least 0.25 meters. For runs longer than 10 meters, separation should be increased proportionally. For example, if the parallel runs were 50m, then the separation would be $(50/10) \times 0.25\text{m} = 1.25\text{m}$.
- 'Sensitive' cables should cross 'noisy' cables at 90°.
- Never run 'sensitive' cables close or parallel to either the Motor, DC Link or Dynamic Brake circuits for any distance.
- Never run AC Line Supply, DC Link or Motor cables in the same bundle as either the Signal / Control or Feedback cables, even if they are screened.
- Ensure the optional External EMC Filter input and output cables are separately routed and do not couple across the filter.

AC Line Supply Cable	
Cable Type:	Unscreened
Segregation:	From all other wiring (clean)
Length Limit:	Unlimited
External EMC Filter to Drive Input Cable	
Cable Type:	Screened / Armoured
Segregation:	From all other wiring (noisy)
Length Limit:	0.3m
Screen to Earth:	Both ends
Motor Cable	
Cable Type:	Screened / Armoured
Segregation:	From all other wiring (noisy)
Length Limit:	50m (up to 300m with an output choke)
Screen to Earth:	Both ends
Brake Cable	
Cable Type:	Screened / Armoured
Segregation:	From all other wiring (noisy)
Length Limit:	25m
Screen to Earth:	Both ends
Signal / Control Cables	
Cable Type:	Screened
Segregation:	From all other wiring (sensitive)
Length Limit:	25m
Screen to Earth:	Drive end only

Mitigating Radiated Emissions

To mitigate against the effects of radiated emissions, the following considerations should be made when installing the Drive within a Variable Speed Drive (VSD) system:

1. Equipment Placement

Magnetic / Electric Field sensitive equipment should not be placed within 0.25 meters of the following components in the VSD system:

- Variable Speed Drive (VSD)
- EMC Output Filters
- Input or Output Chokes / Transformers
- The cable between VSD and motor (even when screened/armoured)
- Connections to external braking chopper and resistor (even when screened/armoured)
- AC/DC brushed motors (due to commutation)
- DC link connections (even when screened/armoured)

- Relays and contactors (even when suppressed)

2. Additive Emissions

Emissions from individual components tend to be additive. To reduce the emissions:

- The equipment must be mounted in a metal cubicle. Refer to 'Radiated & Conducted Emissions: Compliance Overview' section above.
- The cubicle should be as free of openings as is practical. Vent systems suitable for EMC applications are available from cubicle vendors and should be used.

3. Radiated Magnetic & Electric Fields

Radiated magnetic and electric fields inside the cubicle will be high and any components fitted inside must be sufficiently immune:

- All cable entry and exits (power, control, and communication) should use screened cable
- Earth screen at both ends connecting to the motor frame and cubicle.
- Use of screened/armored cable between VSD/cubicle and motor containing the motor protective earth (PE) connection is most important. If shielded cable is not available, lay unshielded motor cables in a metal conduit which will act as a shield. The conduit must be continuous with a direct electrical contact to the VSD and motor housing. If links are necessary, use braid with a minimum cross-sectional area of 10mm² (8 AWG).
- Use 360° screen terminations:

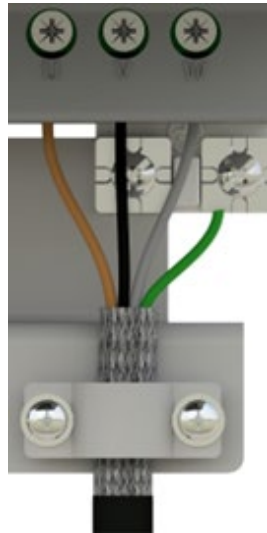

4. Installations in Hazardous Areas

Some installations in hazardous areas may preclude direct earthing at both ends of the screen. In this case earth one end of the screen cable via a 1μF 50Vac capacitor, and the other as normal:

- Keep unshielded cable as short as possible inside the cubicle.
- Always maintain the integrity of the shield. If the cable is interrupted to insert contactors etc., re-connect the screen using the shortest possible route. Some motor gland boxes and conduit glands are made of plastic. If this is the case, then braid must be connected between the screen and the chassis. In addition, at the motor end, ensure that the screen is electrically connected to the motor frame since some terminal boxes are insulated from the frame by gasket/paint.
- Keep the length of screen stripped-back as short as possible when making screen connections.

Issues arising from long Motor Cable runs

Because cable capacitance and hence conducted emissions increase with motor cable length, conformance to EMC limits is only guaranteed up to a maximum cable length as specified in the table in the 'Cabling Requirement' section above.

Screened/armoured cable has significant capacitance between the conductors and screen, which increases linearly with cable length - typically 200pF/m, though this varies with cable type and current rating.

Long cable lengths may have the following undesirable effects:

- Drive 'overcurrent' trip events as the cable capacitance is charged and discharged at the switching frequency.
- Increased conducted emissions that degrade the performance of the internal EMC filter due to common mode choke saturation.
- Increased heating inside the internal EMC filter (as a consequence of a saturated common mode choke).
- RCD (Residual Current Devices) trips, due to increased high frequency earth current.

These effects can be overcome by adding the following:

- External EMC Filter (Input or Output), located as close as possible to the drive
- AC Line Chokes
- AC Motor Chokes

Refer to 'Chapter 7: Associated Equipment' for recommended Associated Equipment.

For RCD trips, internal Y-Capacitor and Overvoltage Suppressors to earth connections can be removed by means of a link disconnect. Refer to 'Chapter 6: Installation' for details on how to disconnect them from earth.

11.2.5 Harmonic Information

1Ø, 230V Products

Drive Type: 1Ø, Fundamental Voltage = 230V

Line Inductance = 146µH, PSCC = 5kA

These products are designated as "Professional Equipment" as defined in EN61000-3-2.

Frame Size:	1		
Product Code:	15G-11-0025...	15G-11-0045...	15G-11-0070...
Power Rating (kW):	0.37	0.75	1.5
Current Rating (A):	2.5	4.5	7
Harmonic No.	RMS Current (A)		
1	3.13	6.26	10.40
3	2.48	4.28	5.91
5	1.47	1.66	1.09
7	0.52	0.28	0.94
9	0.17	0.55	0.34
11	0.28	0.16	0.37
13	0.15	0.21	0.15
15	0.05	0.15	0.20
17	0.11	0.07	0.07
19	0.07	0.11	0.12
21	0.02	0.02	0.04
23	0.06	0.07	0.08
25	0.04	0.03	0.02
27	0.01	0.04	0.06
29	0.03	0.04	0.01
31	0.02	0.02	0.04
33	0.01	0.03	0.00
35	0.02	0.00	0.03
37	0.01	0.02	0.00
39	0.01	0.01	0.02
40	0.00	0.00	0.00
Total RMS Current (A):	4.33	7.80	12.06
THD: Current (%):	94.27	74.15	58.72

Drive Type: 1ϕ, Fundamental Voltage = 230V	
Line Inductance = 146μH, PSCC = 5kA	
Frame Size:	2
Product Code:	15G-12-0100...
Power Rating (kW):	2.2
Current Rating (A):	10
Harmonic No.	RMS Current (A)
1	15.48
3	7.32
5	0.41
7	1.19
9	0.32
11	0.38
13	0.26
15	0.11
17	0.19
19	0.02
21	0.11
23	0.05
25	0.05
27	0.06
29	0.01
31	0.05
33	0.01
35	0.03
37	0.02
39	0.01
40	0.00
Total RMS Current (A):	17.18
THD: Current (%):	48.16

3 ϕ , 230V Products**Drive Type: 3 ϕ , Fundamental Voltage = 230V**Line Inductance = 84 μ H, PSCC = 5kA

These products are designated as "Professional Equipment" as defined in EN61000-3-2.

Frame Size:	1		
Product Code:	15G-31-0025...	15G-31-0045...	15G-31-0070...
Power Rating (kW):	0.37	0.75	1.5
Current Rating (A):	2.5	4.5	7
Harmonic No.	RMS Current (A)		
1	1.90	3.70	6.02
3	0.00	0.01	0.01
5	1.34	2.22	3.28
7	0.91	1.21	1.52
9	0.00	0.00	0.00
11	0.21	0.30	0.46
13	0.16	0.36	0.47
15	0.00	0.00	0.00
17	0.16	0.10	0.12
19	0.09	0.13	0.21
21	0.00	0.00	0.00
23	0.07	0.08	0.03
25	0.07	0.05	0.10
27	0.00	0.00	0.00
29	0.02	0.06	0.01
31	0.03	0.03	0.05
33	0.00	0.00	0.00
35	0.03	0.04	0.02
37	0.01	0.03	0.03
39	0.00	0.00	0.00
40	0.00	0.00	0.00
Total RMS Current (A):	2.52	4.51	7.05
THD: Current (%):	87.00	69.67	61.21

Drive Type: 3 ϕ , Fundamental Voltage = 230V

Line Inductance = 84 μ H, PSCC = 5kA

The 2.2kW Frame 2 is designated as "Professional Equipment" as defined in EN61000-3-2.

Frame Size:	2	3	4
Product Code:	15G-32-0100...	15G-33-0170...	15G-34-0210...
Power Rating (kW):	2.2	4	5.5
Current Rating (A):	10	17	21
Harmonic No.	RMS Current (A)		
1	9.21	16.09	20.04
3	0.01	0.01	0.01
5	4.07	5.40	6.08
7	1.22	0.35	0.42
9	0.01	0.01	0.01
11	0.80	1.33	1.53
13	0.33	0.20	0.49
15	0.00	0.01	0.01
17	0.34	0.62	0.68
19	0.13	0.22	0.39
21	0.00	0.01	0.01
23	0.19	0.35	0.34
25	0.06	0.19	0.28
27	0.00	0.01	0.01
29	0.12	0.21	0.16
31	0.03	0.16	0.19
33	0.00	0.01	0.01
35	0.09	0.12	0.06
37	0.02	0.12	0.12
39	0.00	0.01	0.01
40	0.00	0.00	0.00
Total RMS Current (A):	10.19	17.50	21.02
THD: Current (%):	47.36	35.01	31.80

Drive Type: 3ϕ, Fundamental Voltage = 230V		
Line Inductance = 84μH, PSCC = 5kA		
Frame Size:	5	
Product Code:	15G-35-0300...	15G-35-0400...
Power Rating (kW):	7.5	11
Current Rating (A):	30	40
Harmonic No.	RMS Current (A)	
1	29.14	39.02
3	0.02	0.02
5	7.40	8.42
7	1.65	2.88
9	0.02	0.02
11	1.72	1.47
13	1.03	1.24
15	0.02	0.01
17	0.53	0.08
19	0.55	0.32
21	0.01	0.01
23	0.08	0.30
25	0.23	0.11
27	0.01	0.01
29	0.11	0.21
31	0.04	0.19
33	0.01	0.01
35	0.13	0.05
37	0.07	0.11
39	0.01	0.01
40	0.00	0.00
Total RMS Current (A):	30.19	40.07
THD: Current (%):	27.06	23.38

3 ϕ , 480V Products**Drive Type: 3 ϕ , Fundamental Voltage = 480V**Line Inductance = 146 μ H, PSCC = 5kA

These products are designated as "Professional Equipment" as defined in EN61000-3-2.

Frame Size:	1		
Product Code:	15G-41-0012...	15G-41-0002...	15G-41-0040...
Power Rating (kW):	0.37	0.75	1.5
Current Rating (A):	1.2	2	4
Harmonic No.	RMS Current (A)		
1	1.15	1.90	3.74
3	0.00	0.00	0.00
5	0.86	1.42	2.62
7	0.63	1.04	1.77
9	0.00	0.00	0.00
11	0.20	0.33	0.38
13	0.11	0.16	0.30
15	0.00	0.00	0.00
17	0.12	0.19	0.29
19	0.09	0.15	0.16
21	0.00	0.00	0.00
23	0.04	0.05	0.13
25	0.05	0.07	0.13
27	0.00	0.00	0.00
29	0.04	0.06	0.04
31	0.02	0.03	0.06
33	0.00	0.00	0.00
35	0.03	0.04	0.05
37	0.03	0.04	0.02
39	0.00	0.00	0.00
40	0.00	0.00	0.00
Total RMS Current (A):	1.59	2.63	4.94
THD: Current (%):	95.93	95.58	86.08

Drive Type: 3 ϕ , Fundamental Voltage = 480VLine Inductance = 146 μ H, PSCC = 5kA

These products are designated as "Professional Equipment" as defined in EN61000-3-2.

Frame Size:	2		3
Product Code:	15G-42-0065...	15G-42-0090...	15G-43-0120...
Power Rating (kW):	2.2	4	5.5
Current Rating (A):	6.5	9	12
Harmonic No.	RMS Current (A)		
1	5.99	8.21	10.76
3	0.00	0.00	0.00
5	3.90	5.26	6.23
7	2.39	3.14	3.22
9	0.00	0.00	0.00
11	0.39	0.36	0.76
13	0.54	0.68	0.93
15	0.00	0.00	0.00
17	0.29	0.30	0.15
19	0.12	0.11	0.34
21	0.00	0.00	0.00
23	0.20	0.23	0.11
25	0.11	0.10	0.12
27	0.00	0.00	0.00
29	0.10	0.13	0.10
31	0.10	0.11	0.03
33	0.00	0.00	0.00
35	0.03	0.05	0.09
37	0.06	0.08	0.02
39	0.00	0.00	0.00
40	0.00	0.00	0.00
Total RMS Current (A):	7.58	10.28	12.90
THD: Current (%):	77.59	75.39	66.30

Drive Type: 3 ϕ , Fundamental Voltage = 480V

Line Inductance = 146 μ H, PSCC = 5kA

The 7.5kW Frame 3 is designated as "Professional Equipment" as defined in EN61000-3-2.

Frame Size:	3	4	
Product Code:	15G-43-0170...	15G-44-0230...	15G-44-0320...
Power Rating (kW):	7.5	11	15
Current Rating (A):	17	23	32
Harmonic No.	RMS Current (A)		
1	14.89	20.72	29.15
3	0.00	0.00	0.00
5	7.70	9.33	12.44
7	3.30	3.00	3.45
9	0.00	0.00	0.00
11	1.28	1.80	2.42
13	1.02	0.81	0.77
15	0.00	0.00	0.00
17	0.42	0.73	1.00
19	0.46	0.31	0.23
21	0.00	0.00	0.00
23	0.17	0.39	0.55
25	0.25	0.14	0.08
27	0.00	0.00	0.00
29	0.08	0.24	0.35
31	0.15	0.07	0.06
33	0.00	0.00	0.00
35	0.04	0.17	0.24
37	0.10	0.04	0.07
39	0.00	0.00	0.00
40	0.00	0.00	0.00
Total RMS Current (A):	17.17	23.02	32.00
THD: Current (%):	57.49	48.44	45.34

Drive Type: 3ϕ, Fundamental Voltage = 480V			
Line Inductance = 146μH, PSCC = 5kA			
Frame Size:	5		
Product Code:	15G-45-0380...	15G-45-0440...	15G-45-0600...
Power Rating (kW):	18.5	22	30
Current Rating (A):	38	44	60
Harmonic No.	RMS Current (A)		
1	35.14	41.08	56.17
3	0.00	0.00	0.00
5	13.81	15.11	19.19
7	2.85	2.22	1.53
9	0.00	0.00	0.00
11	2.87	3.27	4.21
13	0.41	0.05	0.57
15	0.00	0.00	0.00
17	1.24	1.42	1.77
19	0.08	0.29	0.70
21	0.00	0.00	0.00
23	0.69	0.77	0.88
25	0.16	0.32	0.59
27	0.00	0.00	0.00
29	0.43	0.45	0.44
31	0.17	0.29	0.43
33	0.00	0.00	0.00
35	0.28	0.27	0.22
37	0.16	0.24	0.30
39	0.00	0.00	0.01
40	0.00	0.00	0.00
Total RMS Current (A):	38.00	43.98	60.06
THD: Current (%):	43.21	40.28	38.32

11.3 North American & Canadian Compliance

11.3.1 North American Compliance

This product is certified under the US governments Occupational Safety and Health Administration's (OHSA), Nationally Recognised Testing Laboratory (NRTL) program. An NRTL is a private third-party organisation accredited by OSHA to test and certify products to national standards for compliance with North American requirements.

11.3.2 Canadian Compliance

Products have been approved to UL61800-5-1 – Adjustable Speed Electrical Power Drive Systems – Part 5-1: Safety Requirements – Electrical, Thermal and Energy, and to the Canadian Standard CSA 22.2 No. 274 - Adjustable speed drives.

11.3.3 North American & Canadian Compliance Information

Short-Circuit Current Rating (SCCR)

The drive have been designed to operate on the following PSCC supply ratings:

Frame Size	SCCR Rating (A_{rms} , Symmetrical Amperes, 480V Maximum)
1	50,000
2	50,000
3	50,000
4	50,000
5	50,000

Note: 50,000 amp SCCR rating valid when used with the recommended UL fuses.

Where drive are to be used on higher rated supplies, refer to 'Chapter 7: Associated Equipment' for recommended AC line chokes.

Branch Circuit Protection

It is recommended that UL Listed fuses are installed upstream of the drive. Branch circuit protection must be provided in accordance with the latest edition of the National Electrical Code NEC/NFPA-70.

Refer to 'Chapter 7: Associated Equipment' for recommended fuse ratings.

Solid State Short-Circuit Protection

The drive provides Solid-State Short-Circuit (output) protection.

Solid State Motor Overload Protection

The drive provides Class 10 motor overload protection. The internal overload protection level (current limit) is 150% for 60 seconds.

Refer to 'DOC-0017-05, Chapter 10: Programming Your Application' for more information on the current limit operation and user adjustment.

An external motor overload protective device must be provided by the installer where the motor has a full-load Ampere rating of less than 50% of the drive output rating or when the **Disable Stall** trip is enabled; or when the **Stall time** parameter is increased above 480 seconds.

Refer to 'DOC-0017-05, Chapter 10: Programming Your Application' for more information on the stall trip.

Motor over temperature sensing is provided by the product when an external temperature sensor (of type PTC or NTC) is connected to the motor thermistor input on the control board.

Recommended Wire Sizes

North American wire sizes (AWG) are based on NEC/NFPA-70 for ampacities of thermoplastic-insulated (75°C) copper conductors.

The wire sizes allow for an ampacity of 125% of the rated input and output amperes for motor branch-circuit conductors as specified in NEC/NFPA-70.

Refer to 'Chapter 6: Installation' for recommended wire sizes.

Field Wiring Temperature Rating

Use minimum 75°C Copper conductors.

11.4 Environmental Compliance

11.4.1 REACH (Restriction, Evaluation, Authorisation & Restriction of Chemicals)

The Regulation (EC) No 1907/2006 of the European Parliament and of the Council of 18 December 2006 concerning the Registration, Evaluation, Authorization, and Restriction of Chemicals (REACH) entered into force on June 1, 2007.

Parker agrees with the purpose of REACH, which, is to ensure a high level of protection of human health and the environment. Parker is compliant with all applicable requirements of REACH.

The registration requirements do not apply to Parker since it is neither a manufacturer nor an importer of preparations into Europe. However, product (article) manufacturers or importers into Europe are obligated under Article 33 of REACH to inform recipients of any articles that contain chemicals on the Substances of Very High Concern (SVHC) candidate list above a 0.1% concentration (by weight per article).

Parker will continue to monitor the developments of the REACH legislation and will communicate with our customers according to the requirement above.

11.4.2 RoHS (Restriction of Hazardous Substances)

This product is in full compliance with RoHS Directive 2011/65/EU, including Commission Delegated Directive (EU) 2015/865 which amends Annex II, with respect to the following substances:

1. Lead (Pb)
2. Mercury (Hg)
3. Cadmium (Cd)
4. Hexavalent Chromium (Cr (VI))
5. Polybrominated Biphenyls (PBB)
6. Polybrominated Diphenyl Ethers (PBDE)
7. Bis(2-ethylhexyl) Phthalate (DEHP)
8. Butyl Benzyl Phthalate (BBP)
9. Dibutyl Phthalate (DBP)
10. Diisobutyl Phthalate (DIBP)

11.4.3 WEEE (Waste Electrical & Electronic Equipment)

Drive fall under the category of “Waste Electrical and Electronic Equipment”, and hence must not be disposed of with domestic waste:



These products must be collected separately, in accordance with local legislation and applicable laws.

Parker Hannifin Manufacturing, together with local distributors and in accordance with EU directive 2012/19/EU, undertakes to withdraw and dispose of its products while fully respecting environmental considerations.

For more information about how to recycle your Parker supplied waste equipment, please contact your local Parker Repair Centre.

The packaging used in the safe transport of our products is environmentally compatible and should be taken for central disposal as secondary raw material.

12 AC15 Series Product Codes

	1		2	3		4		5	6
Order example	15G	-	1	1	-	0025	-	B	F

1	Device Family
15G	AC15 Series, General Purpose AC Drive
2	Voltage
1	230Vac, Single Phase
3	230Vac, Three Phase
4	480Vac, Three Phase
3 & 4	Frame Size and Current Rating (Heavy Duty)
	Frame Size - Current Rating (Power)
	230Vac, Single Phase Supply Voltage
1-0025	Frame 1 (2.5A, 0.5HP)
1-0045	Frame 1 (4.5A, 1HP)
1-0070	Frame 1 (7A, 2HP)
2-0100	Frame 2 (10A, 3HP)
	230Vac, Three Phase Supply Voltage
1-0025	Frame 1 (2.5A, 0.5HP)
1-0045	Frame 1 (4.5A, 1HP)
1-0070	Frame 1 (7A, 2HP)
2-0100	Frame 2 (10A, 3HP)
3-0170	Frame 3 (17A, 5HP)
4-0210	Frame 4 (21A, 7.5HP)
5-0300	Frame 5 (30A, 10HP)
5-0400	Frame 5 (40A, 15HP)
	480Vac, Three Phase Supply Voltage
1-0012	Frame 1 (0.9A, .05HP)
1-0020	Frame 1 (1.7A, 1HP)
1-0040	Frame 1 (3.5A, 2HP)
2-0065	Frame 2 (5.7A, 3HP)
2-0090	Frame 2 (7.8A, 5HP)
3-0120	Frame 3 (10A, 7.5HP)
3-0170	Frame 3 (15A, 10HP)
4-0230	Frame 4 (20A, 15HP)
4-0320	Frame 4 (28A, 20HP)
5-0380	Frame 5 (33A, 25HP)
5-0440	Frame 5 (38A, 30HP)
5-0600	Frame 5 (52A, 40HP)
5	Brake Switch
B	Brake Switch Fitted
6	EMC Filter
F	Category C3 Filtered

13 Technical Information

13.1 General Product Ratings

13.1.1 Environment

Operating Temperature:	0°C to 40°C (derate output current above 40°C by 2% per °C, up to maximum of 45°C). Derate not available for fan-less Frame 1, 1ø 230V, 0.5 HP product.
Storage Temperature:	-25°C to 55°C
Shipping Temperature:	-25°C to 70°C
Altitude:	0 – 1000m (derate output current above 1000m by 1% per 100m, up to maximum of 2000m)
Humidity:	Maximum 90% relative humidity, non-condensing
Atmosphere:	Non-flammable, non-corrosive, dust free
Chemically Active Substances:	Complies with C3 according to EN ISO 9223
Vibration & Shock:	Vibration: <ul style="list-style-type: none"> - 10 – 57Hz: Amplitude to 0.075mm - 57 – 150Hz: Acceleration to 10m/s² Shock: <ul style="list-style-type: none"> - 5g for 30msec
Product Enclosure Rating:	IP20 panel mount (UL: open-type).

13.1.2 Safety

Oversvoltage Category:	III (Control Module User Relay terminals: RL1A, RL1B are category II (230V TN))
Pollution Degree:	II (non-conductive pollution, except for temporary condensation)
North America / Canada:	Complies with the requirements of UL61800-5-1 as an open-type drive

13.1.3 Earthing

Earthing:	Permanent earthing is mandatory for product installation: <ul style="list-style-type: none"> - Use a copper productive earth conductor with a minimum 10mm² (8 AWG) cross-sectional area or, where not possible, install a 2nd conductor to a separate earth terminal. - The earth conductor must meet local requirements for a protective earth conductor.
Earth Leakage Current:	>10mA (all models)

13.1.4 Mains Supply

Input Supply Details (TN & IT):	Products are suitable for use on TN supplies, with the exception of TN corner earthed distribution systems. Products are suitable for use on IT supplies when all Y-Cap & VDR connections to earth are removed.
Short Circuit Current Rating (SCCR):	50kA: All models when fitted with specified UL fusing 5kA: All models when not fitted with specified UL fusing. Line currents are specified at this supply rating.

13.2 AC Line Fed Power Stack Ratings

13.2.1 1 ϕ , 230V Products

AC15 HP	Frame size	Catalog number	Output amps	Input amps	Efficiency %	Switching freq KHz nominal / max	Current Derate % / KHz
0.5	1	15G-11-0025-BF	2.5	4.1	93.0	"4 / 10"	8.0
1		15G-11-0045-BF	4.5	8.2	94.0	"4 / 10"	5.5
2		15G-11-0070-BF	7	14	95	"4 / 10"	6.5
3	2	15G-12-0100-BF	10	18	96	"4 / 10"	6.3

13.2.2 3 ϕ , 230V Products

AC15 HP	Frame size	Catalog number	Output amps	Input amps	Efficiency %	Switching freq KHz nominal / max	Current Derate % / KHz
0.5	1	15G-31-0025-BF	2.5	2.4	91	"4 / 10"	9.0
1		15G-31-0045-BF	4.5	4.7	93	"4 / 10"	9.3
2		15G-31-0070-BF	7	7.9	95	"4 / 10"	8.3
3	2	15G-32-0100-BF	10	10	95	"4 / 10"	6.2
5	3	15G-33-0170-BF	17	17	96	"4 / 10"	4.8
7.5	4	15G-34-0210-BF	21	22	97	"4 / 10"	2.2
10	5	15G-35-0300-BF	30	28	97	"4 / 10"	3.2
15		15G-35-0400-BF	40	39	97	"4 / 10"	2.0

13.2.3 3 ϕ , 480V Products

AC15 HP	Frame size	Catalog number	Output amps	Input amps	Efficiency %	Switching freq KHz nominal / max	Current Derate % / KHz
0.5	1	15G-41-0012-BF	0.9	1.1	91	"4 / 10"	8.3
1		15G-41-0020-BF	1.7	2.3	93	"4 / 10"	8.3
2		15G-41-0040-BF	3.5	3.8	95	"4 / 10"	8.3
3	2	15G-42-0065-BF	5.7	5.2	95	"4 / 10"	8.3
5		15G-42-0090-BF	7.8	8.1	96	"4 / 10"	7.2
7.5	3	15G-43-0120-BF	10	11.3	96	"4 / 10"	7.8
10		15G-43-0170-BF	15	13.3	96	"4 / 10"	6.3
15	4	15G-44-0230-BF	20	19	97	"4 / 10"	5.0
20		15G-44-0320-BF	28	25	97	"4 / 10"	4.5
25	5	15G-45-0380-BF	33	30	97	"4 / 10"	4.0
30		15G-45-0440-BF	38	35	98	"4 / 10"	5.3
40		15G-45-0600-BF	52	46	96	"4 / 10"	5.8

13.3 Internal Brake Switch Ratings

13.3.1 1 \emptyset , 230V Products

DC Link Brake Switch Threshold = 382V							
Frame Size	Product Code	Motor Power (HP)	Continuous		Peak (Instant)		Min Resistor Value (Ω)
			Brake Current (A)	Power Diss (kW)	Brake Current (A)	Power Diss (kW)	
1	15G-11-0025...	0.5	1.0	0.37	4.8	1.8	80
	15G-11-0045...	1	2.0	0.75	4.8	1.8	80
	15G-11-0070...	2	3.9	1.5	4.8	1.8	80
2	15G-12-0100...	3	4.8	1.8	4.8	1.8	80

Note: Peak (Instant) = Maximum 20sec, 30% 'on' duty (except where this value is the same as the continuous rating)

13.3.2 3 \emptyset , 230V Products

DC Link Brake Switch Threshold = 382V							
Frame Size	Product Code	Motor Power (HP)	Continuous		Peak (Instant)		Min Resistor Value (Ω)
			Brake Current (A)	Power Diss (kW)	Brake Current (A)	Power Diss (kW)	
1	15G-11-0025...	0.5	1.0	0.37	4.8	1.8	80
	15G-11-0045...	4	2.0	0.75	4.8	1.8	80
	15G-11-0070...	2	3.9	1.5	4.8	1.8	80
2	15G-12-0100...	3	4.8	1.8	4.8	1.8	80
3	15G-33-0170...	5	10.5	4.0	12.7	4.9	30
4	15G-34-0210...	7.5	12.7	4.9	12.7	4.9	30
5	15G-35-0300...	10	19.6	7.5	25.5	9.7	15
	15G-35-0400...	15	28.8	11.0	34.7	13.3	11

Note: Peak (Instant) = Maximum 20sec, 30% 'on' duty (except where this value is the same as the continuous rating)

13.3.3 3 ϕ , 480V Products

DC Link Brake Switch Threshold = 764V							
Frame Size	Product Code	Motor Power (HP)	Continuous		Peak (Instant)		Min Resistor Value (Ω)
			Brake Current (A)	Power Diss (kW)	Brake Current (A)	Power Diss (kW)	
1	15G-41-0012...	0.5	0.5	0.37	5.3	4.0	145
	15G-41-0020...	1	1.0	0.75	5.3	4.0	145
	15G-41-0040...	2	2.0	1.5	8.0	6.1	95
2	15G-42-0065...	3	2.9	2.2	8.5	6.5	90
	15G-42-0090...	5	5.2	4.0	8.5	6.5	90
3	15G-43-0120...	7.5	7.2	5.5	8.5	6.5	90
	15G-43-0170...	10	8.5	6.4	8.5	6.5	90
4	15G-44-0230...	15	14.4	11.0	15.3	11.7	50
	15G-44-0320...	20	19.6	15.0	25.5	19.5	30
5	15G-45-0380...	25	24.2	18.5	25.5	19.5	30
	15G-45-0440...	30	25.5	19.5	25.5	19.5	30
	15G-45-0600...	40	30.6	23.3	30.6	23.3	25

Note: Peak (Instant) = Maximum 20sec, 30% 'on' duty (except where this value is the same as the continuous rating)

13.4 Control Board Ratings

13.4.1 Analogue Inputs

Terminal Idents:	AI1, AI2, referenced to 0V
Type:	Voltage Modes: <ul style="list-style-type: none"> - $\pm 10V$ (Frames 2 – 5 only) - 0 – 10V Current Modes: <ul style="list-style-type: none"> - 0 – 20mA - 4 – 20mA (with wire break detection)
Maximum Input Voltage:	$\pm 30V$
Input Impedance:	Voltage Mode: <ul style="list-style-type: none"> - Frame 1: 18kΩ - Frames 2 – 5: 10kΩ Current Mode: <5.5V drop @ 20mA
Resolution:	12 Bit
Isolated:	No
Overcurrent Protection:	Yes (Current Mode only)
Sample / Update Rate:	1msec

13.4.2 Analogue Outputs

Terminal Idents:	AO1, AO2, referenced to 0V
Type:	Voltage Mode: - 0 – 10V Current Mode: - 0 – 20mA
Maximum Output Current:	20mA
Load Impedance:	Voltage Mode: Max current = 20mA Current Mode: Max voltage = 10V
Typical Settling Time:	2.5msec (0 to 90%)
Resolution:	11 Bit
Isolated:	No
Short Circuit Protection:	Yes
Sample / Update Rate:	1msec

Terminal Idents:	AO3, referenced to 0V
Type:	Voltage Mode: - $\pm 10V$ - 0 – 10V
Maximum Output Current:	$\pm 10mA$
Typical Settling Time:	2.5msec (0 to 90%)
Resolution:	11 Bit
Isolated:	No
Short Circuit Protection:	Yes
Sample / Update Rate:	1msec

13.4.3 Digital Inputs

Terminal Idents:	DX1, DX2, DI3, DI4, DI5, DI6, DI7, DI8, referenced to 0V
Nominal Input Voltage:	24V
Maximum Input Voltage:	+ 30V
Input Thresholds:	Typical threshold = 10V: - Low state <5V - High state >15V
Input Current:	>2.5mA in High state Typically: 5mA @ 24V
Selectable Pull-Ups:	Common to all dedicated digital inputs (DI3, DI4, DI5, DI6, DI7 & DI8)
Pull-Up Current Consumption:	>2.5mA in Low state Typically: 3.5mA @ 0V
Isolated:	No
Sample Interval:	1msec

13.4.4 High Speed Digital Inputs

Terminal Idents:	DI4, DI5, referenced to 0V
Input Voltage Range:	5V to 24V logic: - Low state <0.8V - High state >4.2V
Typical Rising Threshold:	2.9V
Typical Falling Threshold:	2.2V
Signaling Type:	Single Ended
Counting Modes:	Quadrature Clock & Direction Clock
Maximum Count Frequency:	100kHz
Duty Cycle:	50% ± 10%
Quadrature Angle:	90° ± 45°

13.4.5 Digital Outputs

Terminal Idents:	DX1, DX2, referenced to 0V
Nominal Output Voltage:	23V
Minimum Output Voltage:	18V @ 50mA
Maximum Output Current:	Frame 1: - 50mA (Each output, or Total outputs & User +24V output combined) Frames 2 – 5: - 50mA (Each output, or Total outputs combined)
Isolated:	No
Short Circuit Protection:	Yes

13.4.6 Relay Outputs

Terminal Idents:	RL1A, RL1B
Maximum Contact Voltage:	230Vac (Overvoltage Category II, TN) / 30Vdc
Maximum Contact Current:	2Arms

13.4.7 Motor Thermistor Input

Terminal Idents:	TH1, TH2
Compatible Thermistors:	PTC & NTC
Trip Threshold:	Rising resistance: 2500Ω to 2800Ω Falling resistance: 1000Ω to 1200Ω
Response Time:	10secs
Thermistor Self Heating:	<15mW @ rising resistance threshold
Isolated:	No – thermistor wiring requires double or reinforced insulation to live voltages

13.4.8 User +24V Output

Terminal Idents:	24V referenced to 0V
Nominal Output Voltage:	23V
Minimum Output Voltage:	20V @ 50mA
Maximum Output Current:	Frame 1: - 50mA (Total combined with DX1 & DX2 outputs) Frames 2 – 5: - 50mA
Isolated:	No
Over Current Protection:	Yes

13.4.9 External +24V Auxiliary Input

Allows for the partial power-up of the product without mains power applied, for programming of the drive using the DSELite programming tool through the Ethernet port. μ SD Card port and digital I/O are also active.

Terminal Idents:	0V, 24V
Input Voltage:	24V +/-10% (up to a maximum ambient temperature of 40°C) 24V +5 / -10% (up to a maximum ambient temperature of 45°C)
Indicative Input Current:	@Nominal 24V: - Control Board only (unloaded): 35mA
Isolated:	No
Over Voltage Protection:	No
Reverse Voltage Protection:	No

13.4.10 STO Inputs

Terminal Idents:	STOA, STOB, referenced to 0V
Nominal Input Voltage:	24V PELV (with energy source class 3, according to IEC 62368-1)
Maximum Input Voltage:	25.2V (26.4V in a maximum operating ambient of 40°C)
Recommended Input Voltage for Logic Low Level:	0V – 5V (or open circuit)
Recommended Input Voltage for Logic High Level:	15V – 24V
Indetermined Input Range:	5V – 15V, function is undefined
Typical Input Current:	9mA @ 24V
STO Input Operability:	Always Active (i.e., STO cannot be disabled by the drive firmware)
STO User Input A Logic Level:	0V or open circuit = STO Activated 24V = STO Disabled
STO User Input B Logic Level:	0V or open circuit = STO Activated 24V = STO Disabled
Isolation:	Channel A & B to SELV: Galvanic Isolation. Channel A to Channel B: Non-isolated

Appendix A: Power Stack Circuit Overview

1Ø, 230V Products

Frame 1:

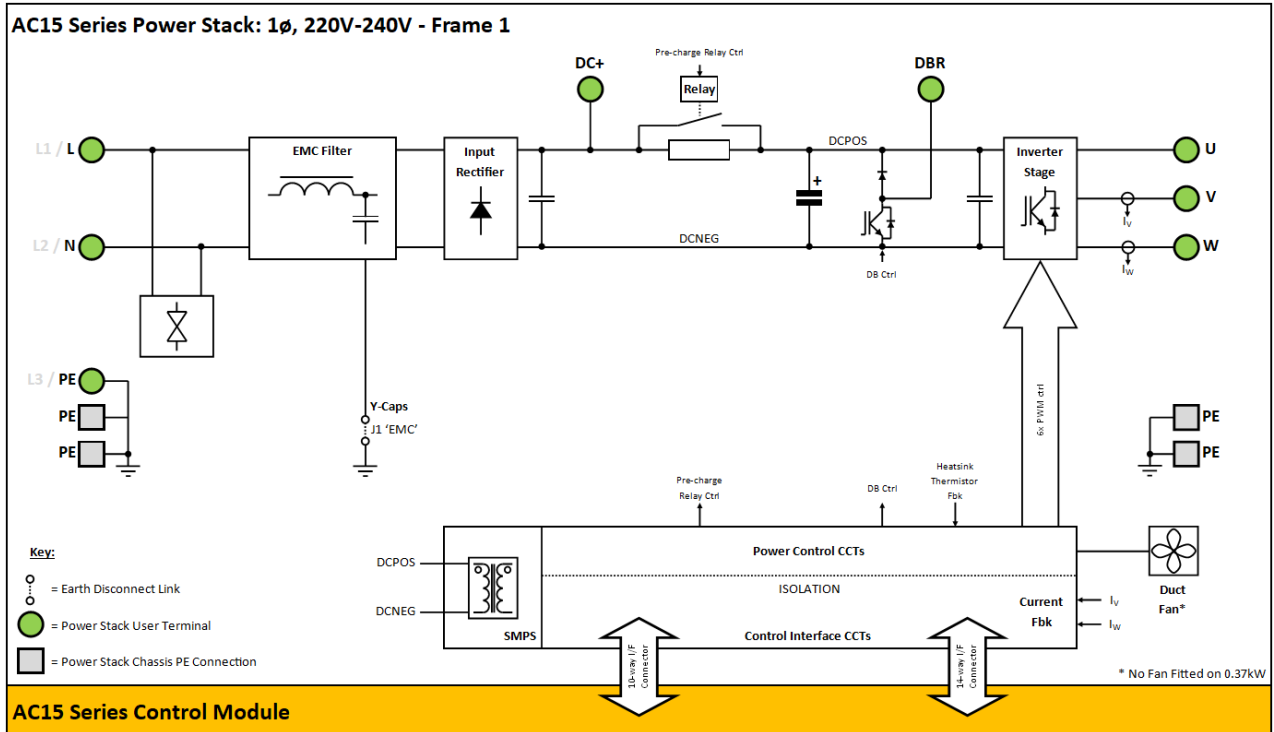

Frame 2:

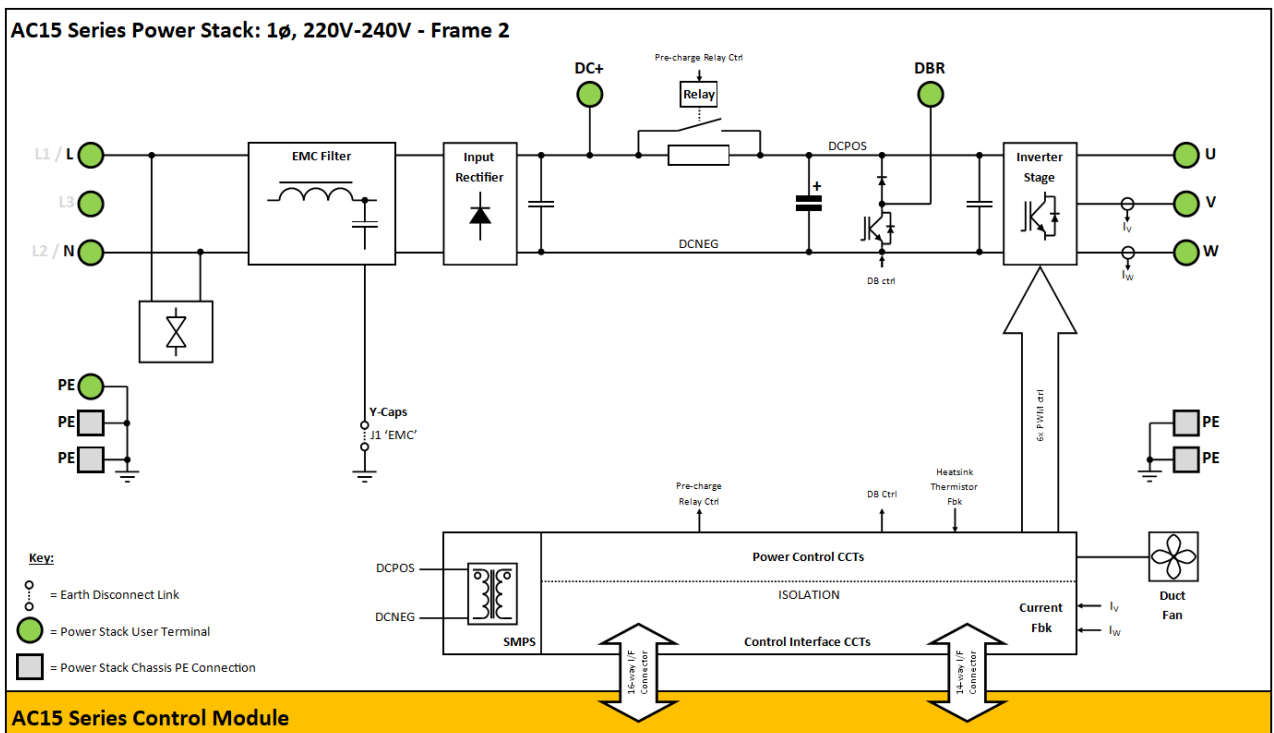

3Ø, 230V Products Frame 1:

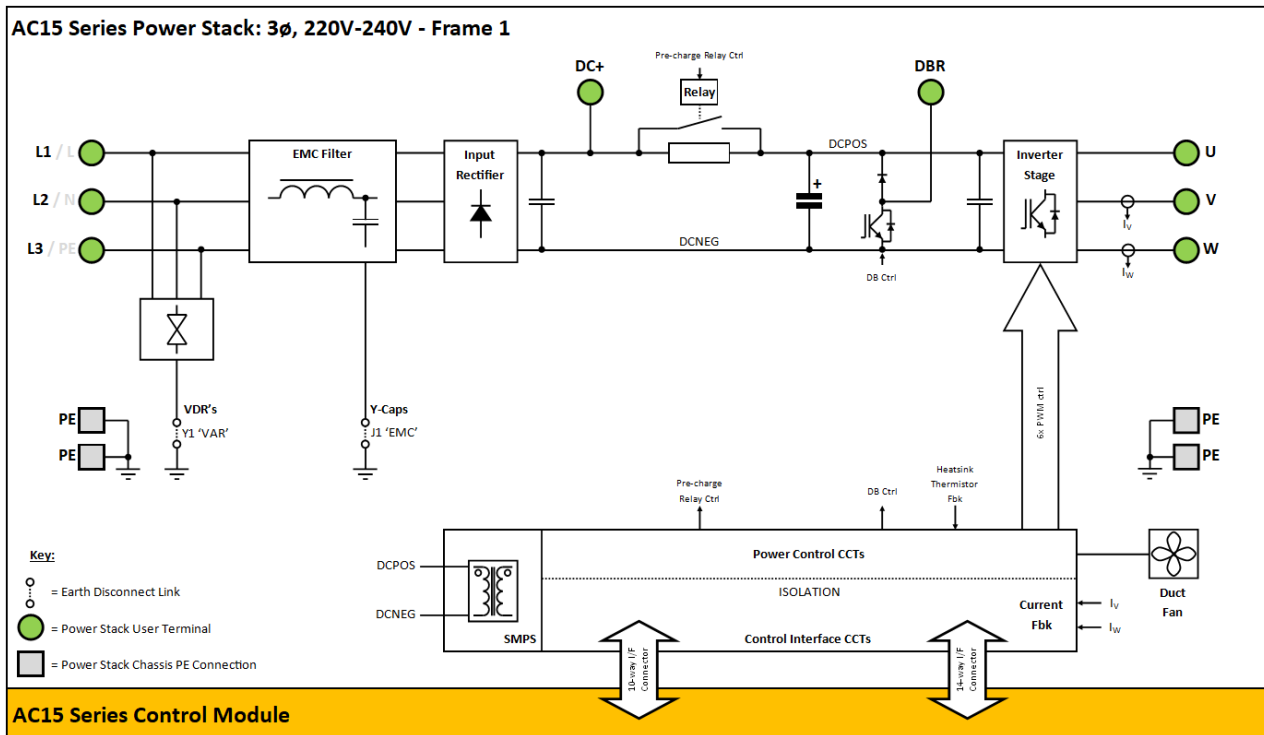

Frame 2:

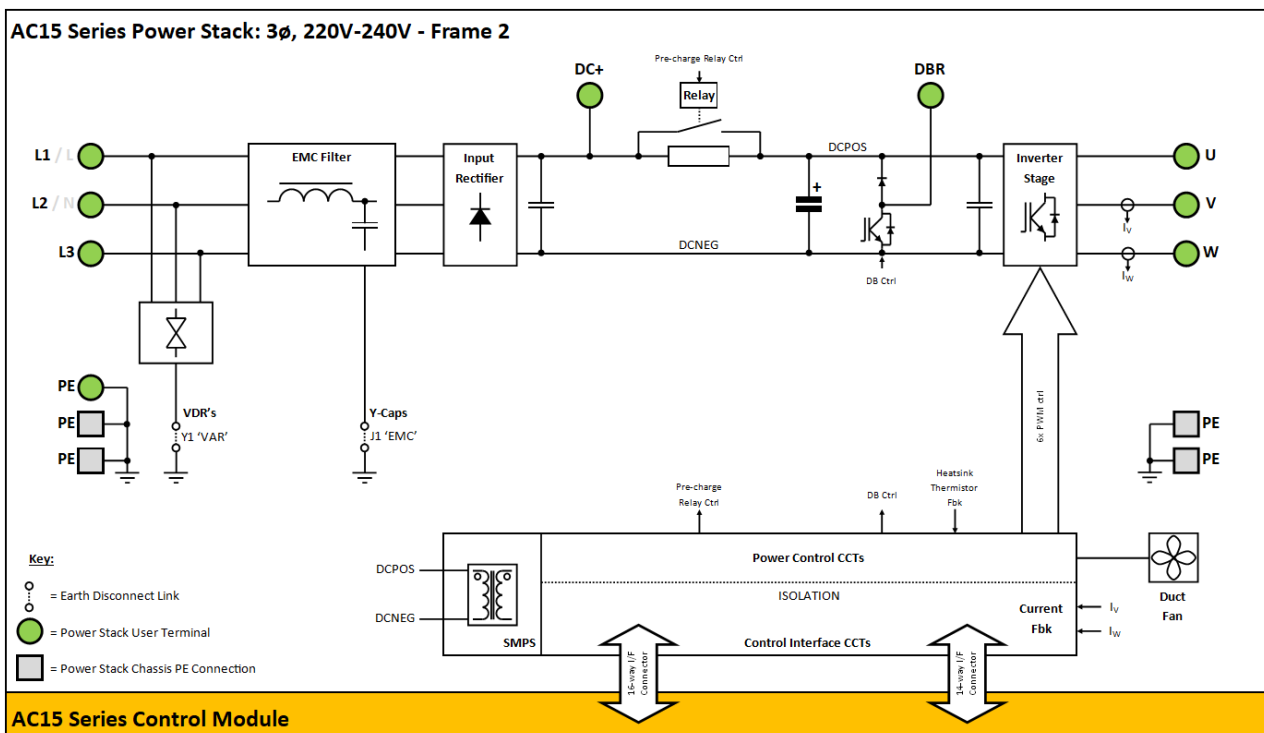

Frame 3:

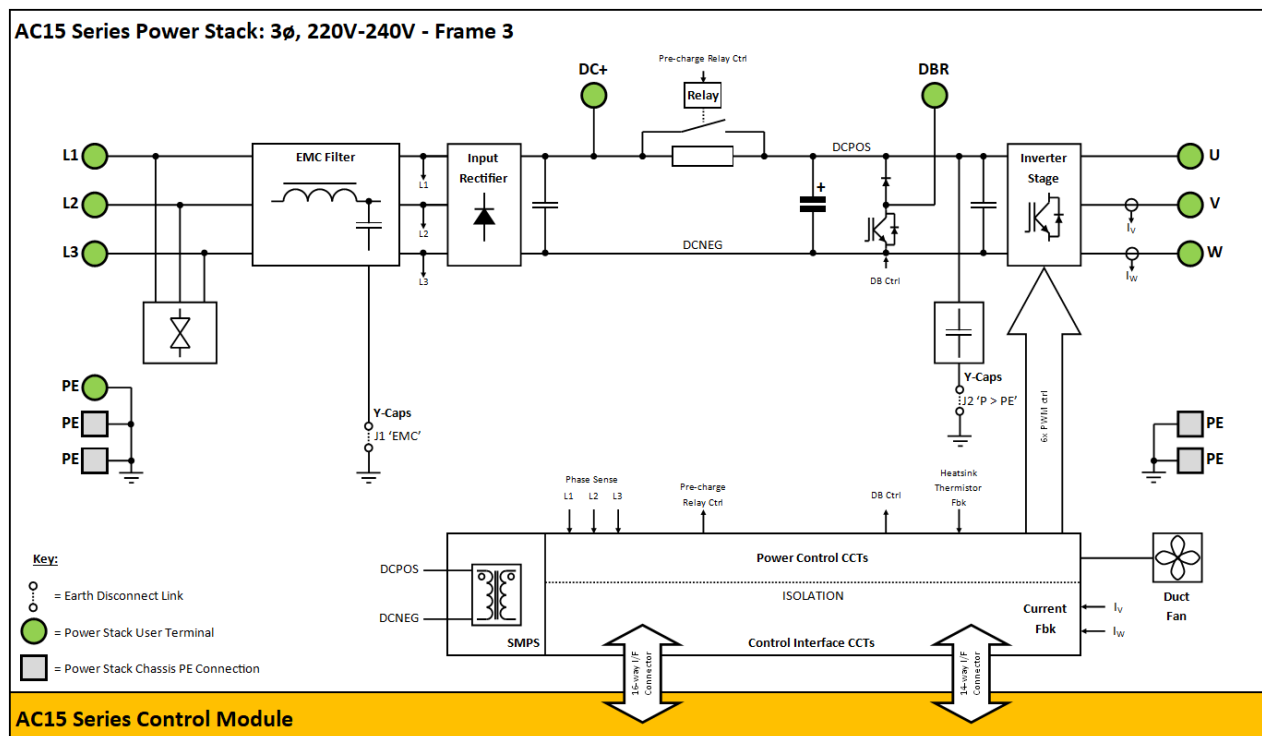

Frame 4:

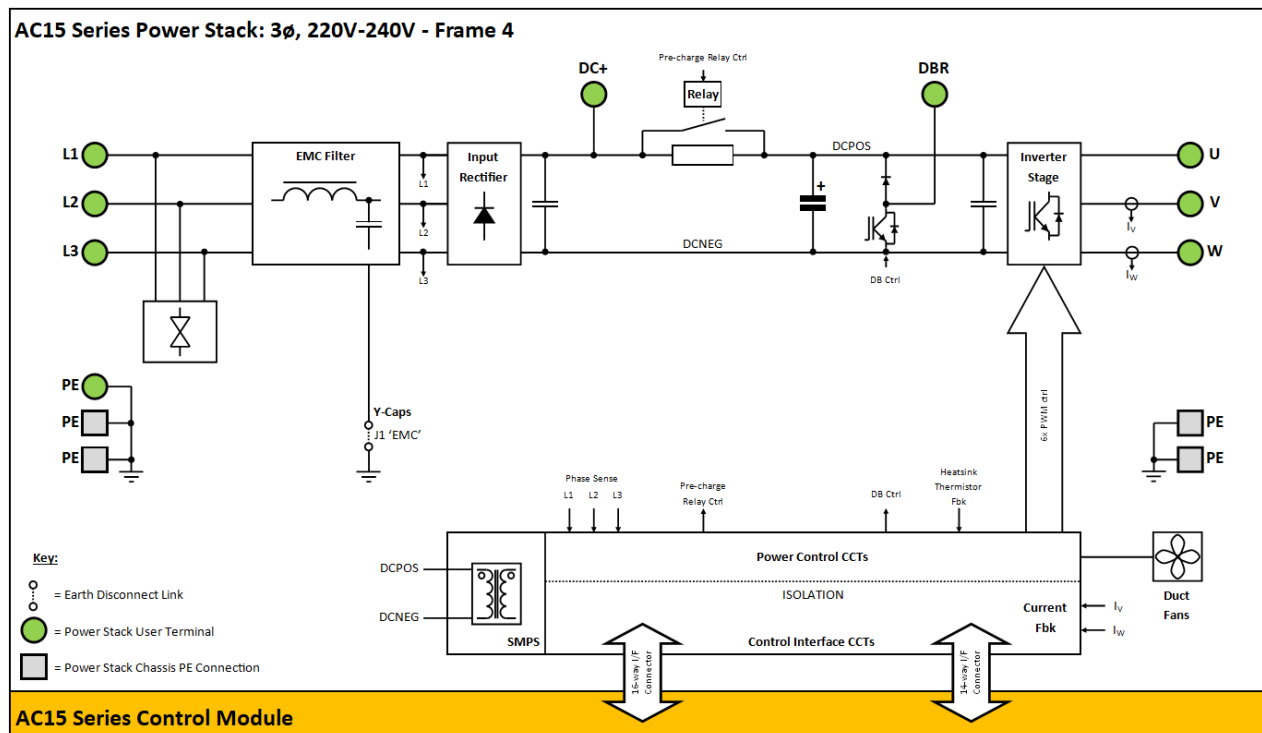

Frame 5:

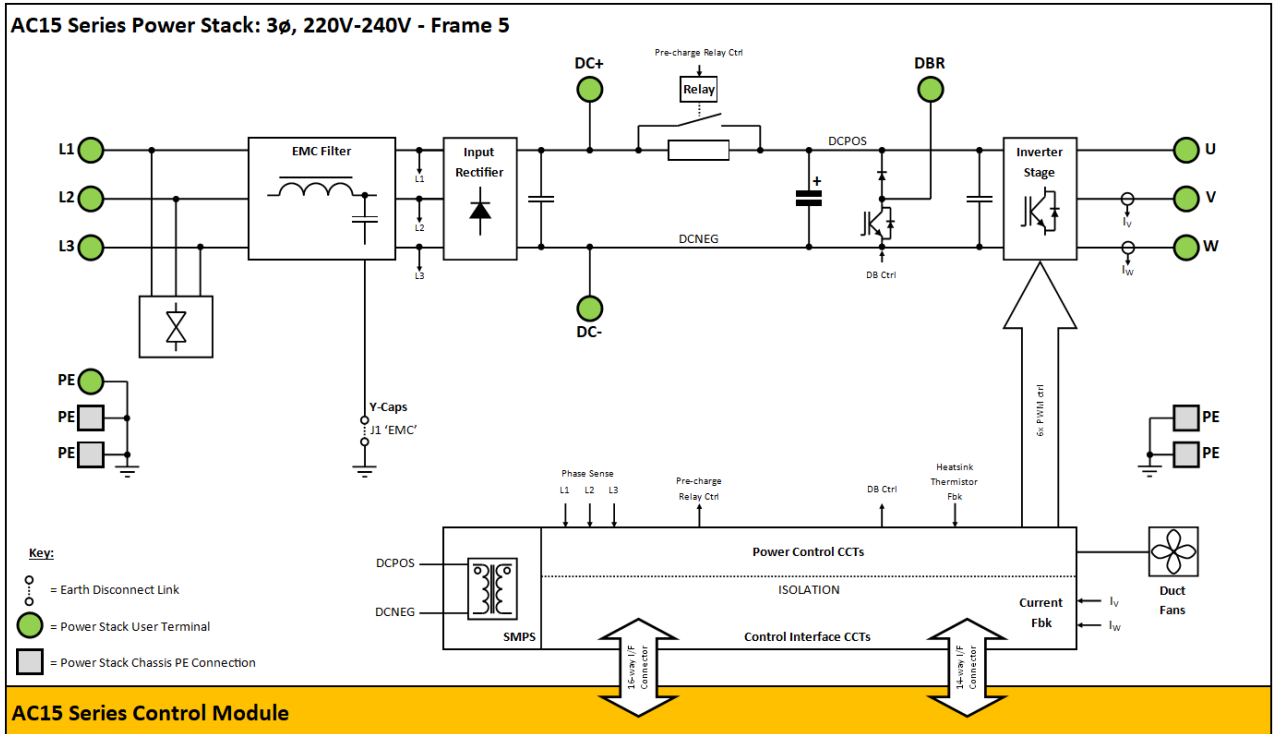

3 ϕ , 480V Products

Frame 1:

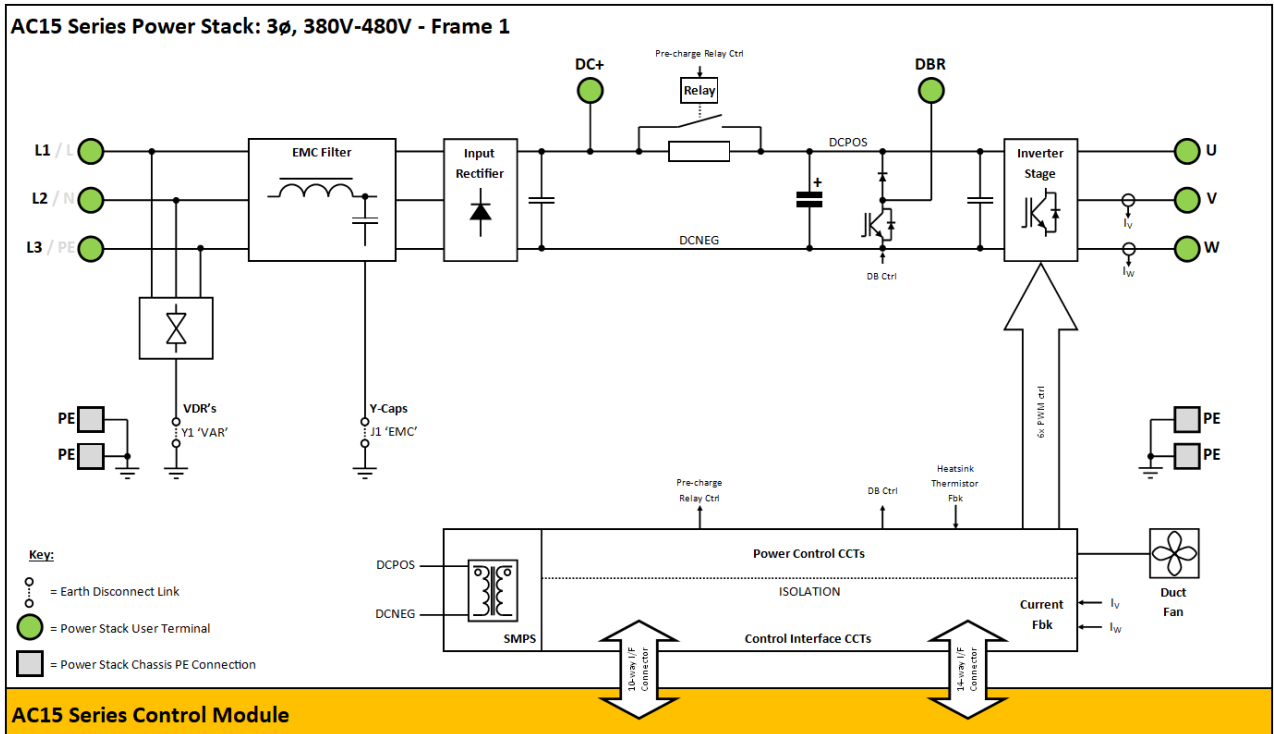

Frame 2:

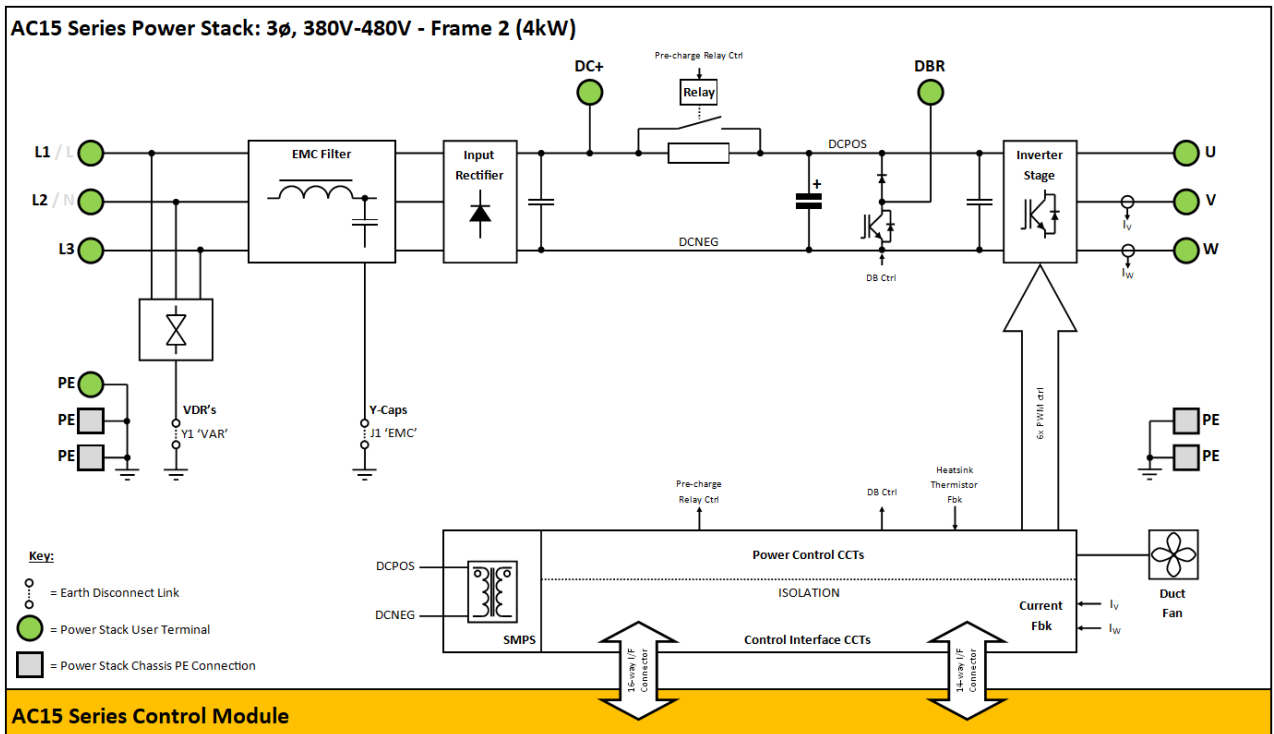
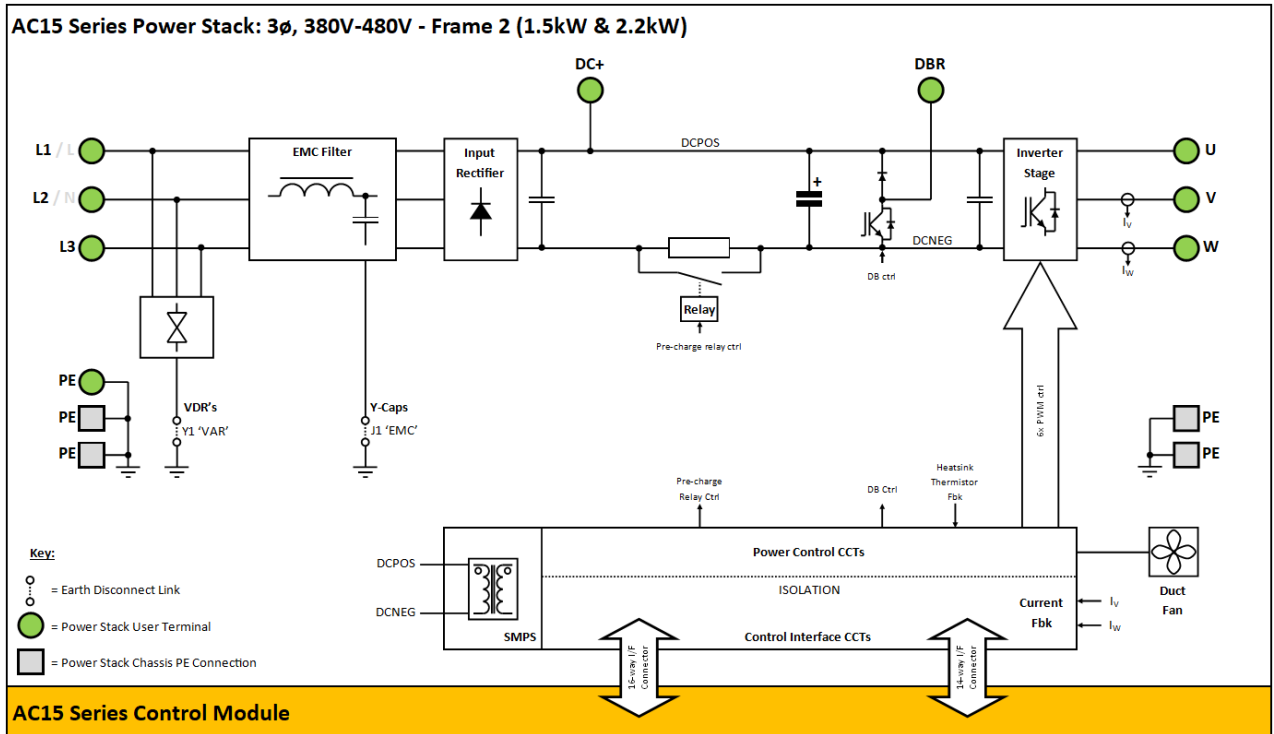

Frame 3:

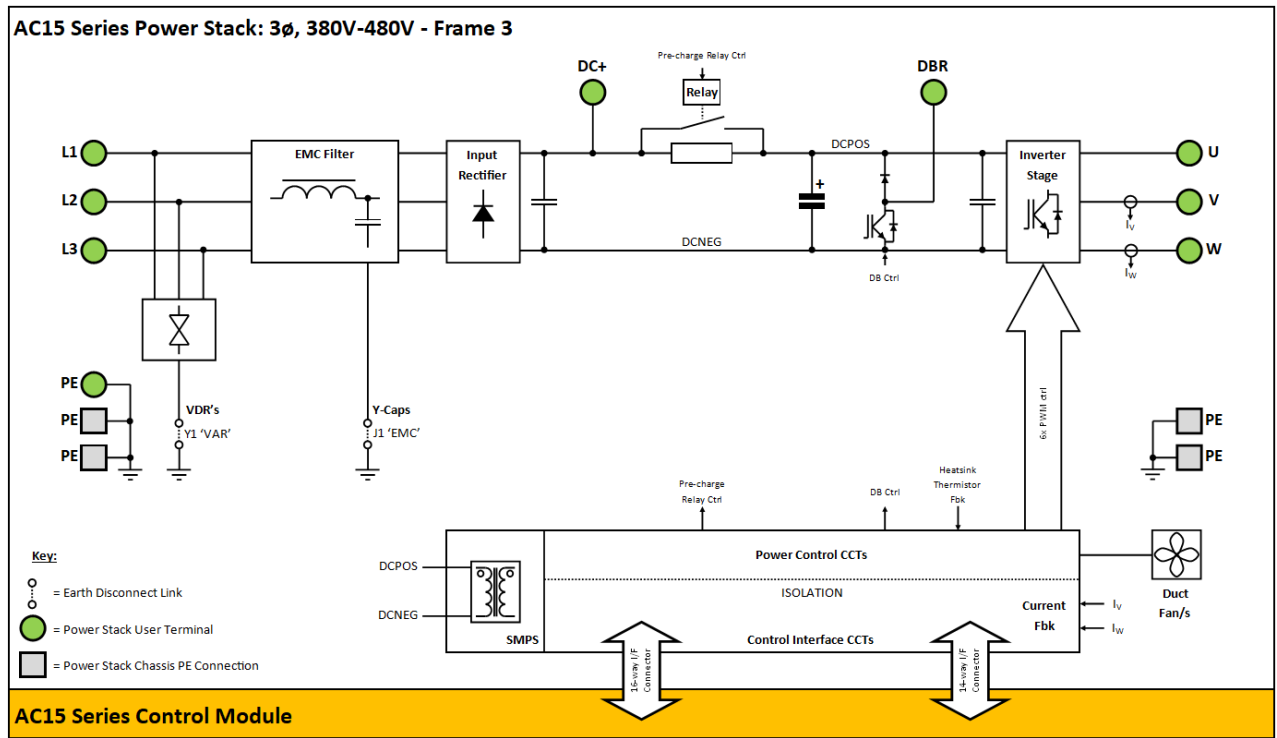

Frame 4:

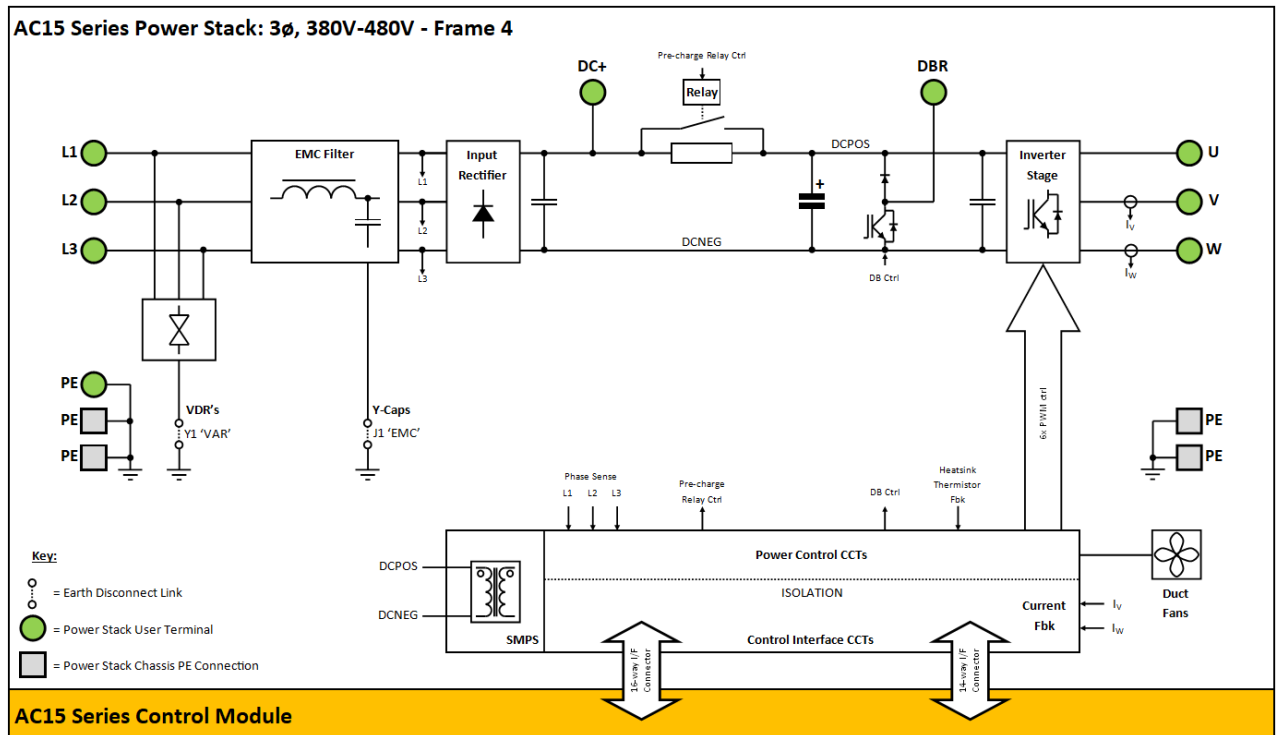

Frame 5:

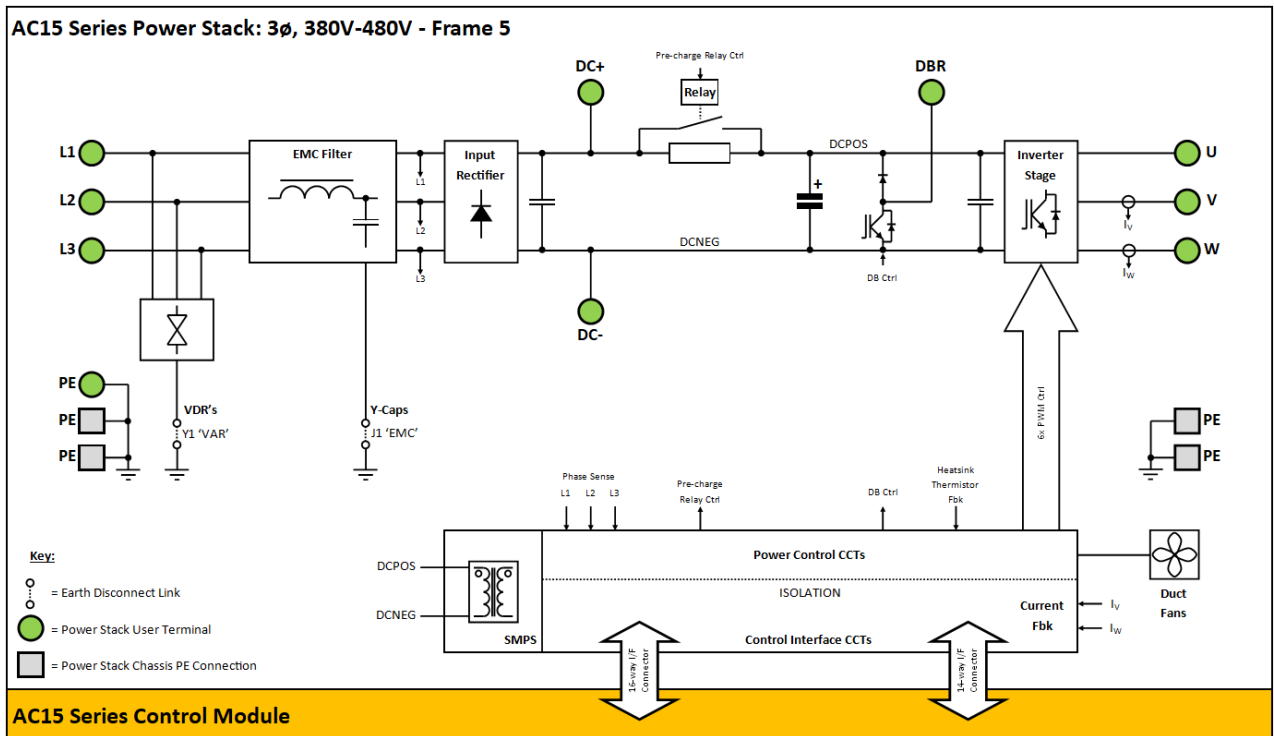

© 2023 Parker Hannifin Corporation. All rights reserved.



Parker Hannifin Corporation
Electronic Motion and Controls Division
Tel: (800) 358-9070
emn.service@support.parker.com
www.parker.com/emc

HA540015 Issue 1